

VanWeigh®

Installation, Setup and Calibration Manual



Important installation information and liability waiver

VPG designs and manufactures on-board vehicle weighing equipment. These installation guidelines are provided solely for the use of trained installers and represent the correct, safe and recommended method of installation.

These guidelines must be followed fully to ensure proper, safe installation. Failure to do so may result in serious consequences including, but not limited to, failure of the system to function properly and damage to the weighing equipment that could jeopardize the stability and safety of the vehicle.

VPG accepts no responsibility or liability for consequences arising from any improper installation of the weighing equipment including but not limited to, any misapplication or misinterpretation of the installation information contained herein.

Strict observance of these guidelines should help to ensure accurate weight measurement and enable safe operation of the vehicle. Failure of our on-board vehicle weighing equipment due to poor installation workmanship or incorrectly installed elements remains solely the responsibility of the installer.

VPG does not accept responsibility for the structural integrity of the vehicle concerned, for any part thereof, and for its proper, safe operation.

The company also reserves the right to make any amendments and alterations to this document deemed necessary. You should ensure you have the current version of this information by contacting VPG prior to performing installation, such as on our website at www.vpgsensors.com

Contents

Important installation information and liability waiver	3	The configuration menu	40
Introduction and scope	6	Login	41
Scope	6	Vehicle configuration	42
About this document	6	How to configure the junction box	43
Document Control	6	How to configure the alarms	47
Important installation information	7	Weighing the Vehicle	48
Installation	9	How to calibrate the junction box	51
Components	10	How to configure the display	54
Tools	14	How to configure a serial output	56
Installation overview	15	How to configure the weighing units	57
Typical system schematics	17	How to configure the PIN Numbers	58
How to install the display unit	18	System info and Diagnostics	59
How to install the junction box	20	System Info	60
Connecting the cables	21	Diagnostics	63
Sensor types	22	Appendix A	67
Sensor installation positions	23	System configuration table	68
Axle transducer on a front strut	24	Zero and span weights tables	69
Axle transducer on a leaf spring	25	Zero weights:	69
Air pressure transducer	26	Span weights:	69
How to install a steel axle transducer	27	Appendix B	71
How to install an air pressure transducer	29	VanWeigh display Molex Microfit 24-way connector	72
System Overview	33	Appendix C	73
VanWeigh® Display Unit Overview	34	VanWeigh II Specification	74
Display unit operation	35	Appendix D	77
Home Page	35	Warning and Status Messages	78
How to navigate the system	36	Alarm / Warning Icons	80
Editing Values	37	Message/Log Error Code Text	81
Configuration	39		

Introduction and scope

VanWeigh® is an overload monitoring system for use on twin axle vehicles with mechanical or air suspension systems.

Scope

This document is intended as a guide to the installation and commissioning of VanWeigh®.

It covers two transducer types currently supported in a VanWeigh® system:

- VanWeigh® axle transducers. These measure suspension deflection on mechanical spring suspension systems
- Air pressure transducers. These measure changes to air pressure on air suspension systems

Different system configurations can be used to support different chassis types. The system can be configured to use either type of transducer and any combination of the two.

About this document

Any display screenshots used in this document are intended as an illustration of the function being described. As such, any specific detail or settings shown will differ from one installation to another.

The documentation uses the following conventions:

Important. These are important notes and appear inside a green border

Caution. These notes warn of an operation that may cause damage to the VanWeigh® system. These notes appear inside an orange border

Warning. These notes warn of an operation that may cause injury to the installer. The note is highlighted in a yellow banner

Document Control

Document Version:	Date:	Version Notes:
v1.0	8 Mar 2019	
v1.2	11 Sept 2019	Software Update V 2.1.4.1, Sept 2019

Important installation information

Please read this installation guide completely to ensure that all instructions are fully understood before you install VanWeigh®

To ensure a reliable and properly functioning system particular importance should be paid to the following:

- VanWeigh® axle transducer installation. A suitable location for the transducer should be carefully identified and that location should then be prepared for the transducer to be attached. See “How to install a steel axle transducer” on page 27
- VanWeigh® axle transducer orientation. Axle transducers must be mounted to the vehicle in the correct orientation. See “How to install a steel axle transducer” on page 27
- Accurate recording of sensor serial numbers in their sensor positions. It is recommended that you use the system configuration table to record this information and refer to it when you are configuring the system. See “System configuration table” on page 68



Installation

Components

Below is a list of components that can be used in a VanWeigh® installation.

Check that you have all of the appropriate components for your installation before starting.

Images are for illustration purposes only. Later versions may differ.

<p>VanWeigh® Display Unit</p> <p>A single VanWeigh® display unit is supplied for the vehicle</p> <p>Part No: 551430</p>	
<p>Display Mount</p> <p>A single display mount is supplied for the display unit</p> <p>Part No: 551430-MOUNT</p>	
<p>Axle Transducer</p> <p>A single cable with a connector at one end and the axle transducer at the other</p> <p>This is supplied for steel axle suspension systems.</p> <p>A single transducer is supplied for each transducer position. See “Sensor installation positions” on page 23.</p> <p>Bonding tape is supplied for each transducer</p> <p>Part No: DRG-106009</p>	

Air Pressure Transducer

The parts for the air pressure transducer are supplied in a bag. A single air transducer is made up from a T-connector, a brass sensor fitting and two plastic air pipe fittings

This is supplied for air suspension systems

A single transducer is supplied for each transducer position. See “Sensor installation positions” on page 23.

Part No: 996210C (For air pipe outside diameter 8mm & 10mm)

Part No: 542549 (Air sensor only)



Internal Domain Cable with Air Transducer Fitting

A single transducer cable is supplied for each air transducer position. See “Sensor installation positions” on page 23.

Part No: DRG-106001



Junction Box

A single junction box is supplied for the rigid vehicle

Part No: 341410



Internal Domain Junction Box Cable 3 way

The cable is identified by the green junction box connector and 3 male internal domain cable connectors

Part No: DRG-106898



External/Internal Domain Junction Box Cable 2 way

A single external domain output cable is supplied for each junction box

The cable is identified by the brown junction box connector at one end and at the other end, one external domain cable connector and one male internal domain cable connector

Part No: DRG-106897



External Domain/Power cable

A single external domain cable is supplied for the system

The cable is identified by the external domain cable connector at one end and the display connector at the other

Part No: DRG-106143



Cable Protector and Cable Ties

Cable protector is supplied and can be cut as required

Cable ties are also supplied

Part No: 493459



Surface Cleaning Wipes

Part No: 995627



Double Sided Bonding Tape

Part No: 995614



Tools

Check that you have the following tools before starting an installation.

Tool	Check
Screwdriver set	
Hex driver set	
Torx driver set	
Socket set	
Multimeter	
Side cutters	
Drill set	
G-Clamp	
Spanner set (including 18 mm and 24 mm)	
Air pipe cutters	

Installation overview

Ensure the engine of the vehicle is off and the parking brake is applied before starting the installation

It is recommended that you use a mechanics pit inside a workshop to install the VanWeigh® system

The VanWeigh® display unit is used to display sensor information once the system has been installed, configured and calibrated.

The display unit is connected to the junction box via the external domain cable. The junction box is installed on the chassis of the vehicle and is connected to all four sensors on the vehicle. The sensors and junction box form the internal domain.

The sensors send information back to the junction box. The junction box then transmits information back to the display unit via the external domain.

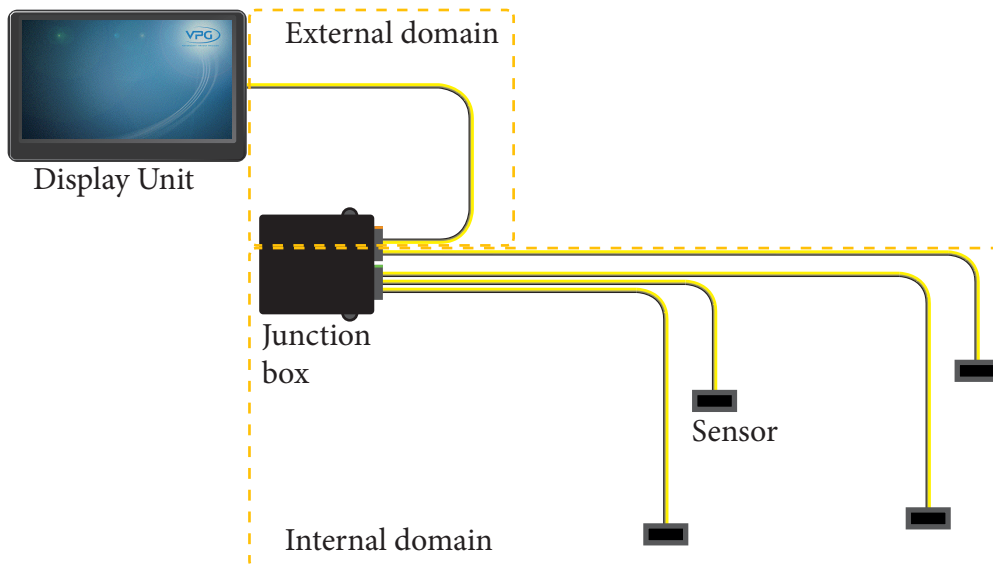

There are three main steps to installing the VanWeigh® system:

- Install the display unit. The display unit must be installed in the cab of the vehicle and connected to the vehicles power supply. The external domain cable must be routed from the display unit to the junction box. See “How to install the display unit” on page 18.
- Junction box installation. This must be installed on the chassis of the vehicle. It must be located in an appropriate position between the suspension systems and the cab of the vehicle. The sensor and display unit cables must be able to reach the junction box.
- Sensor installation. The type of sensors you install will depend on the suspension systems in operation on the vehicle. Air pressure transducers are installed on air suspension systems. Axle transducers are installed on steel axle suspension systems. The sensors must be installed in an appropriate position on the suspension system and their cables must be routed back to the junction box.

It is recommended that the display unit is installed first, followed by the junction box and sensors. However, these steps can be performed in any order.

Typical system schematics

Below are two examples of system schematics showing where the junction box and transducers are fitted in relation to the vehicle. These are two example schematics, but a variety of configurations may be used.

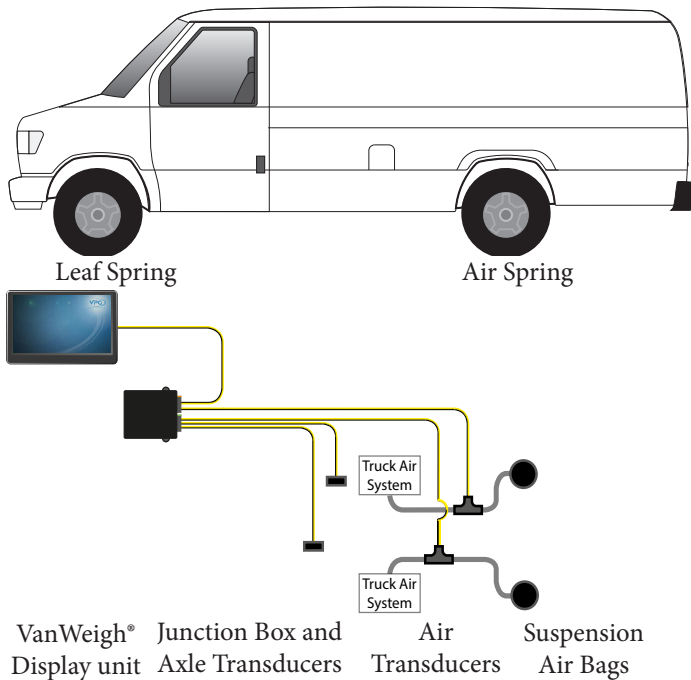
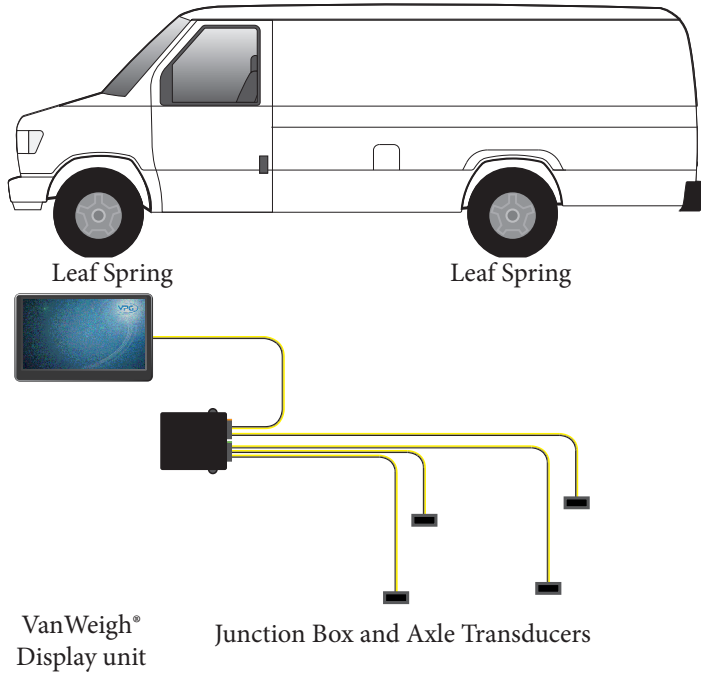

How to install the display unit

A single display unit is installed in the cab of the vehicle to display the sensor information. The display unit has a single port that connects to both the power supply on the vehicle and the junction box, via the external domain cable.

The external domain cable starts in the cab of the vehicle and is routed to the power supply and junction box.

1. Route the power cables on the display unit cable from the location of the display unit in the cab to the appropriate connection point for the power supply in the vehicle
2. Route the external domain cable on the display unit cable from the the location of the display unit in the cab to the location for the junction box
 - Avoid running cables on or near sharp objects
 - Keep cables away from hot components such as exhausts and engines

Use cable protector to protect the cable at positions where it may be exposed to damage

It is recommended that you follow existing cable routes and ensure that the cable is able to plug into the rear of the display unit after it has been mounted

3. Mount the dashboard mount to the vehicle. Mount it to a position that does not obscure the drivers line of sight when driving the vehicle. Ensure that the display unit cable can be routed to the back of the display unit

4. Connect the power cables to the appropriate connection point for the power supply in the vehicle

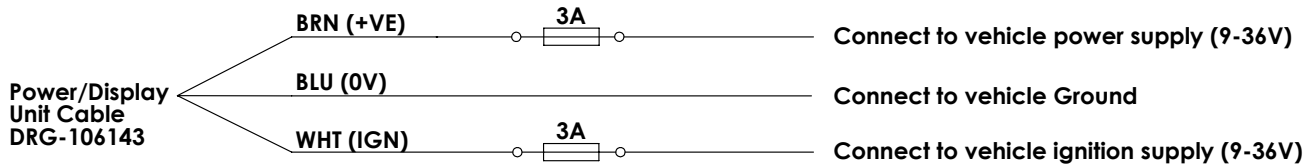

WIRING OPTIONS	+ VE	IGN.	0V	RESULT
1	BROWN	WHITE	BLUE	THE DISPLAY WILL TURN ON BY THE IGNITION KEY AND TURN OFF BY AUTO POWER OFF CONFIGURATION OPTION
2		BROWN & WHITE	BLUE	THE DISPLAY WILL TURN ON/OFF BY THE IGNITION KEY OR THE STAND BY ICON WHEN THE IGNITION IS ON

- The system can be powered from 12V or 24V DC power supplies
 - The system has an operating range of 9V to 36V DC
 - Connect the white wire to the ignition to power the monitor on and off when the ignition is turned on or off
5. Plug the display unit cable into the rear of the display unit
 6. Test the power connection
 7. Mount the display unit into the dashboard mount

How to install the junction box

A single junction box is used to receive information from each sensor in a suspension system.

1. Select a position to install the junction box where:

- The junction box cannot be damaged by any moving parts on the vehicle
- The cables from each sensor can reach the junction box. Ensure the cables can be routed from the transducer without risk of damage from any moving parts on the vehicle
- The external domain cable can reach from the cab of the vehicle to the junction box. Ensure the cable can be routed to the cab without risk of damage from any moving parts

2. Mount the junction box to the vehicle:

- The cable sockets must point to the rear of the vehicle

The VanWeigh® system will not provide the correct measurements if the junction box is not mounted with the cable sockets pointing to the rear of the vehicle

- Use existing holes on the chassis to mount the junction box, if possible. Drill holes appropriate to the size and length of the mounting screws if existing holes are not suitable
- Use 2 X 1/4" or M6 screws with Nyloc nuts to mount the junction box. The length of the screws may vary depending on where you mount it

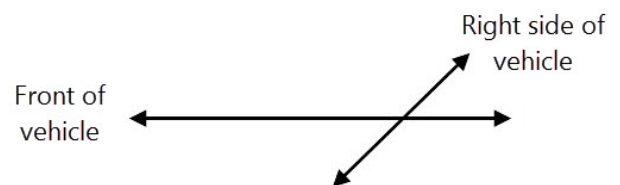

3. Make a note of the orientation of the top face of the junction box, e.g. facing up, down, left or right side of the vehicle. In the example shown above, the junction box is facing down

It is recommended that you use the system configuration table to record this information. See "System configuration table" on page 68

Connecting the cables

The junction box has two ports. These are colour coded to ensure that only the correct cables can be connected to the correct port:

- Port with green tab. This is the connection for the first three sensors. Sensor information is transmitted from the sensors to the junction box via this port.
 - Port with brown tab. This is the connection for the fourth sensor and external domain cable. Sensor information is transmitted from the fourth sensor to the junction box via this port. Information is transmitted to the display unit from this port.
1. Connect the three way sensor input cable to the green port on the junction box
 2. Connect the two way sensor input and external domain connector cable to the brown port on the junction box

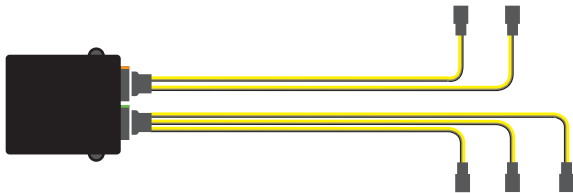

3. Connect the external domain cable from the display unit to the external domain connector cable

Sensor types

Install the appropriate type of sensors on the suspension system of each wheel. There are two types of sensor:

- Axle transducer. This type of sensor can be mounted on steel axle suspension systems. This includes:
 - Front strut type suspension
 - Single axle leaf springs
- Air pressure transducer. This type of sensor can be mounted on air suspension systems

Air pressure transducers can only be used on air suspension systems that are self levelling.

Sensor installation positions

The first step to sensor installation is to select the appropriate position to install each type of sensor on the vehicle.

Each sensor has a serial number. Make a note of the serial number of each sensor which you install, its position number and where it is installed on the vehicle. It is recommended that you use the system configuration table to record this information and refer to it when you are configuring the system. See “System configuration table” on page 68

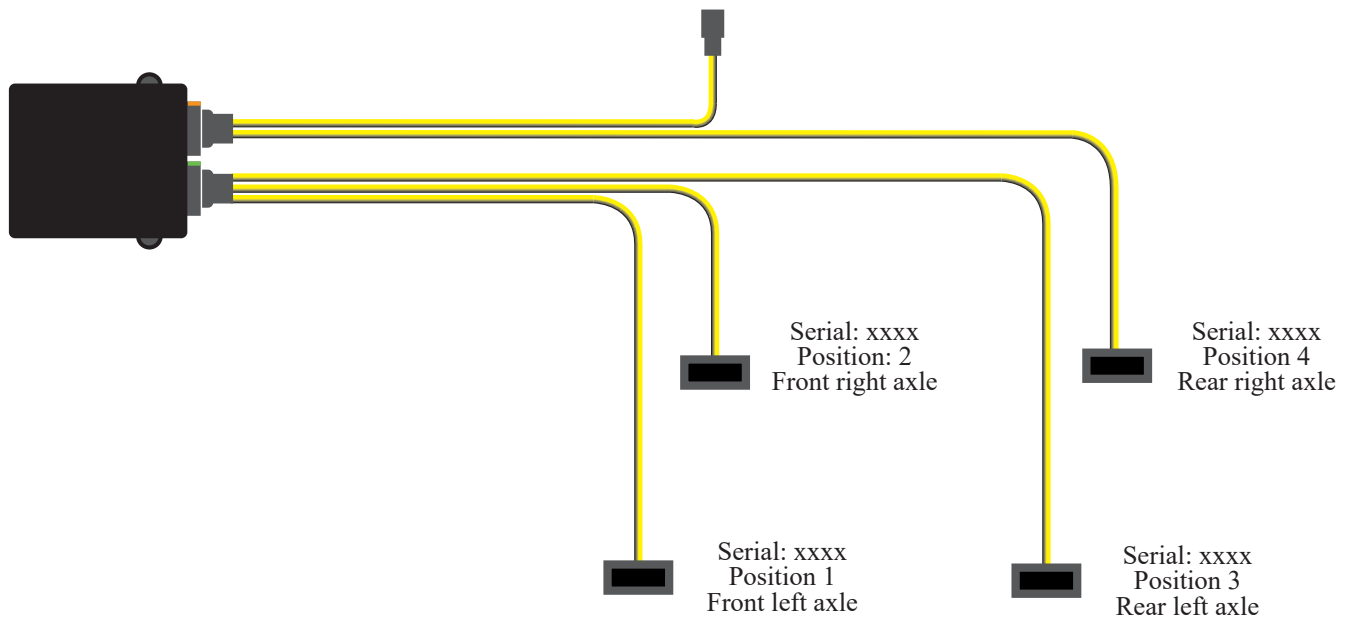

Axle transducer on a front strut

Select a position to install the transducer on a front strut where:

- The transducer is perpendicular to the orientation of the chassis with the cable running away from the wheel
- The transducer is not at risk of damage from any part on the vehicle throughout the full range of movement of the strut
- The sensor cable can be routed to the junction box without risk of damage from any moving parts and allowing for the full range of movement of the transducer on the strut

When mounting the sensor, ensure it is in the correct orientation, with the groove at the top. See “How to install a steel axle transducer” on page 27 for further guidance



Axle transducer on a leaf spring

Select a position to install the transducer on a single axle leaf spring where:

- The transducer is mounted to the top side of the spring
- The transducer is parallel to the orientation of the chassis
- The transducer is as far as possible from the axle. It can be mounted to the front or rear of the spring with the cable running away from the axle
- The transducer is not at risk of damage from any part on the vehicle throughout the full range of movement of the spring
- The cable can be routed to the junction box without risk of damage from any moving parts and allowing for the full range of movement of the transducer on the spring



When mounting the sensor, ensure it is in the correct orientation, with the groove at the top.
See “How to install a steel axle transducer” on page 27 for further guidance

Air pressure transducer

Select a position to install the transducer in an air circuit where:

- The transducer is between the self levelling valve and the air bellows
- The air transducer can be supported without risk of damage from any moving parts
- The cable can be routed to the junction box without risk of damage from any moving parts

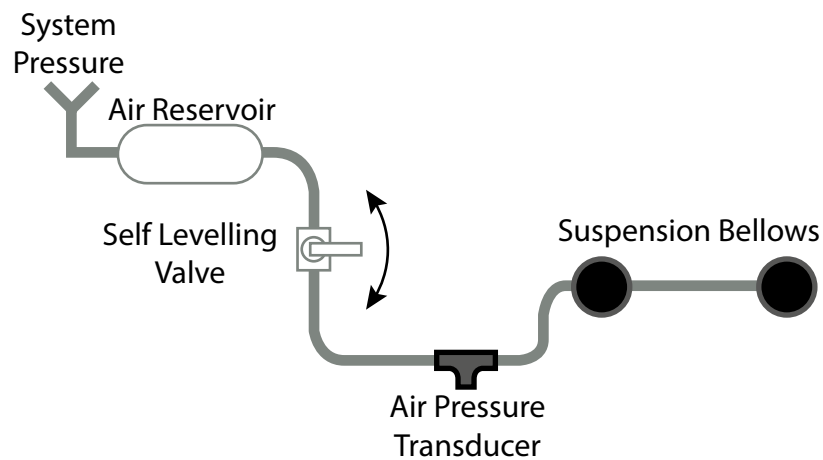

How to install a steel axle transducer

A single axle transducer is used to monitor one side of an axle. In most cases, two axle transducers will be installed per axle, one on the suspension for the left wheel, one on the right.

Ensure that you select the appropriate position for the sensor. Please see “Sensor installation positions” on page 23 for guidance on selecting a position for a sensor

1. Clean and dry the surface where the transducer will be mounted to the suspension system:

- Use brake cleaner and scotchbrite to remove heavy debris
- Use alcohol wipes provided to ensure all grease is removed



Loose paint and rust must be removed. The site must be dry before installation

2. Ensure the mounting surface is at an appropriate temperature:

- The ideal temperature of the mounting surface is 70°F / 21°C
- If required, warm the spring with a hot air gun before bonding the transducer

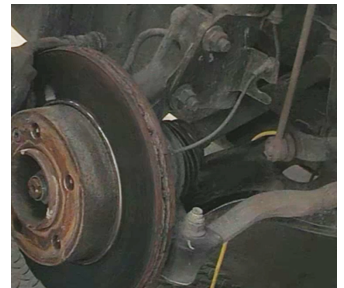

It is not recommended to apply the bonding tape at temperatures below 60°F / 15°C

3. Warm the bonding tape in your hands and apply it to the appropriate side of the sensor:

- The sensor must always be mounted with the face adjacent to the groove pointing up
- The sensor must always be mounted with the internal domain cable pointing towards the pivot point on the suspension system.

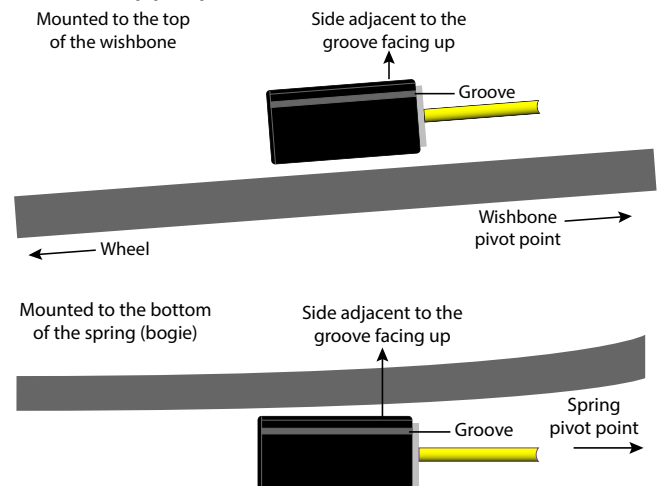

Please see “Sensor installation positions” on page 23 for further guidance on sensor orientation in specific suspension systems

4. Mount the sensor to the suspension and clamp in place for a minimum of 10 minutes
5. Connect the cable to the junction box

- Ensure that cable to cable connections are well supported
- Avoid running cables on or near sharp objects
- Keep cables away from hot components such as exhausts and engines
- Use cable ties to secure any excess cable to the chassis of the vehicle



Use cable protector to protect the cable at positions where it may be exposed to damage

Ensure that you make a note of the serial number of the sensor and the location on the vehicle where it is installed.

6. Make a note of the serial number of the sensor, the position it is located on the vehicle and the direction it is facing e.g. SN: xxxx, position 1, front left sensor, facing forward

- The internal domain cable is attached to the rear of the transducer. The opposite face is used to indicate which direction the sensor is facing

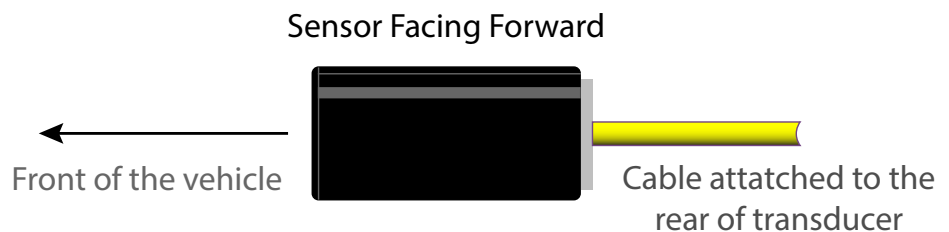

It is recommended that you use the system configuration table to record this information. See "System configuration table" on page 68

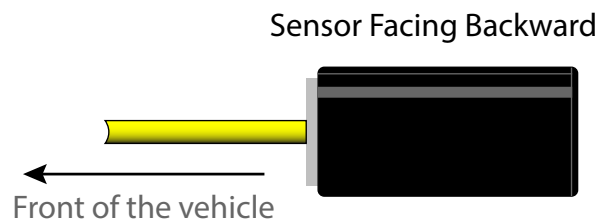

How to install an air pressure transducer

A single air pressure transducer is used to monitor a single air circuit in an air suspension system.

For example; a single air circuit with one ride height control valve that controls multiple bellows on both sides of the vehicle would require a single air pressure transducer.

If separate air circuits are present, a transducer must be installed on each air circuit.

For example; two air circuits, one with a ride height control valve to control the bellows on the left side and one with a ride height control valve to control the bellows on the right, would require two air pressure transducers, one for the circuit on the left side of the truck and one on the right.

Ensure that you select the appropriate position for the sensor. Please see "Sensor installation positions" on page 23 for guidance on selecting a position for a sensor

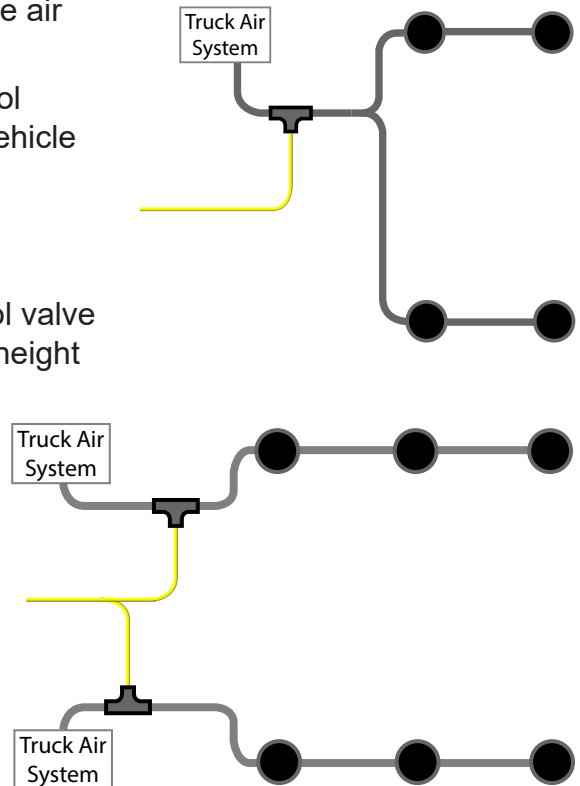

1. Build the air pressure transducer:

- i. Disconnect the fitting from the sensor cable
- ii. Place the washer over the thread. It is recommended that PTFE tape is also applied
- iii. Connect the sensor to the fitting. Use 18 mm and 24 mm spanners to tighten
- iv. Remove the cap from the sensor
- v. Connect the fitting and sensor to the stem of the air pressure T-connector. Push-fit until you hear two clicks to lock the sensor and T-connector together
- vi. Connect the air pipe fittings to each side of the tee on the T-connector. Push-fit until you hear two clicks to lock the air pipe fitting and T-connector together

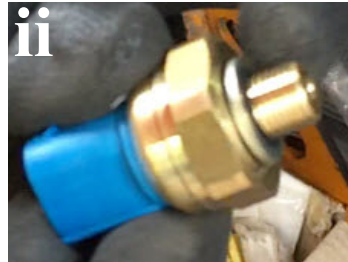

2. Depressurise the air suspension systems

Ensure the air pressure system is fully depressurised to avoid movement in the suspension when the air pipe is cut

3. Reconnect the sensor to the cable

It is recommended that self amalgamating tape is wrapped around the air transducer connector and a little way up the cable to provide protection



4. Cut the air pipe at the appropriate position

5. Cut approximately 1" of pipe off the cut end of the air pipe

6. Clean any dirt from the ends of the air pipe

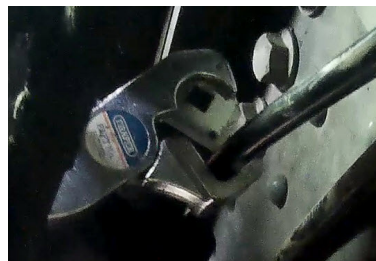

7. Connect the air pipe to each side of the air pressure transducer. Push-fit until you hear one click to lock the pipe into the pipe fittings



8. Connect the sensor cable to the junction box

9. Secure air pipe, transducer and cable to vehicle

- Use cable ties to support air pipe and sensor cable connections. Secure the connectors to existing cables where possible
- Ensure that cable to cable connections are well supported
- Avoid running cables on or near sharp objects
- Keep cables away from hot components such as exhausts and engines
- Use cable ties to secure any excess cable to the chassis of the vehicle

Use cable protector to protect the cable at positions where it may be exposed to damage

Ensure that you make a note of the serial number of the sensor and the location on the vehicle where it is installed.

10. Make a note of the serial number of the sensor and the position it is located on the vehicle, e.g. SN: xxxx, rear left air circuit etc.

It is recommended that you use the system configuration table to record this information. See “System configuration table” on page 68

System Overview

VanWeigh® Display Unit Overview

The display unit is used to display the weight measurements from the sensors on the vehicle.

The display unit must be configured to display any values in the appropriate format and allow any external devices to operate. See “How to configure the display” on page 54 and “” on page 55

The display unit will not display any weight measurements until the system has been:

- Configured to reflect the setup of the sensors and junction boxes on the vehicle. See “Vehicle configuration” on page 42
- Calibrated to accurately show the weight measurements. Once the configuration is complete, see “How to calibrate the junction box” on page 51

The display unit will show a message to indicate the current stage of the configuration and calibration process:

- Axles Sensors Zero Span. This message indicates that a junction box has been detected but the axles and sensors have not been configured, and the zero and span calibrations have not been done.
- Zero Span. This message indicates that a junction box has been detected and the axles and sensors have been configured, but the zero and span calibrations have not been done.
- Span. This message indicates that a junction box has been detected, the axles and sensors have been configured and the zero calibration has been done, but the span calibration has not been done.

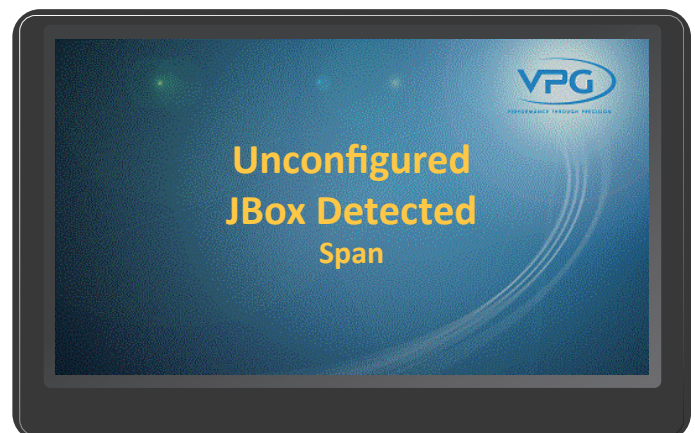
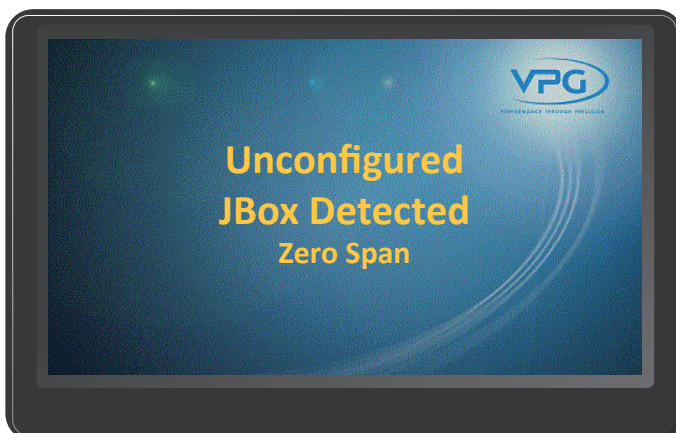
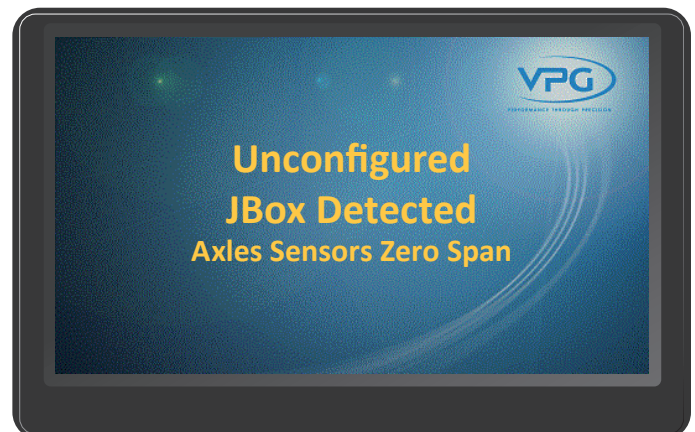

Display unit operation

The display unit is automatically powered on by the ignition. It uses touch screen technology to operate it. Tap the screen to switch the screen on if it is in standby mode.

Home Page

The home page is displayed when the display unit is activated. This shows:

- The total weight of the vehicle and its percentage of the maximum weight that can be applied.
- The weight of the vehicle that is currently over the front axle and its percentage of the maximum weight that can be applied to that axle.
- The weight of the vehicle that is currently over the rear axle and its percentage of the maximum weight that can be applied to that axle.

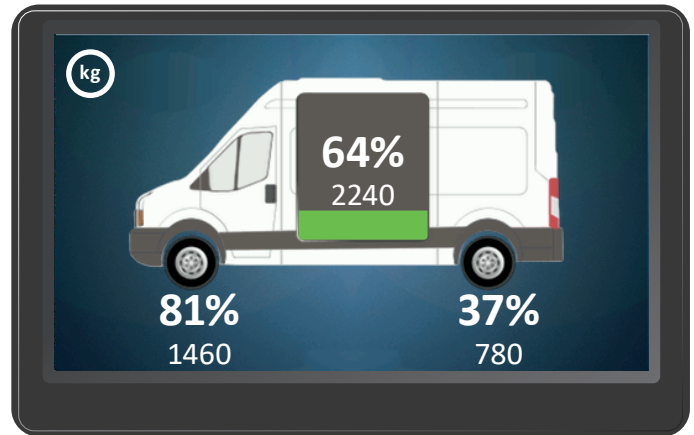

Swipe left or right for alternative displays of this information:

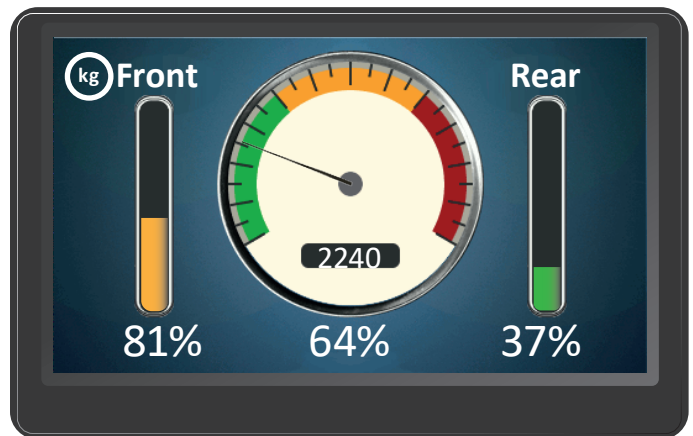
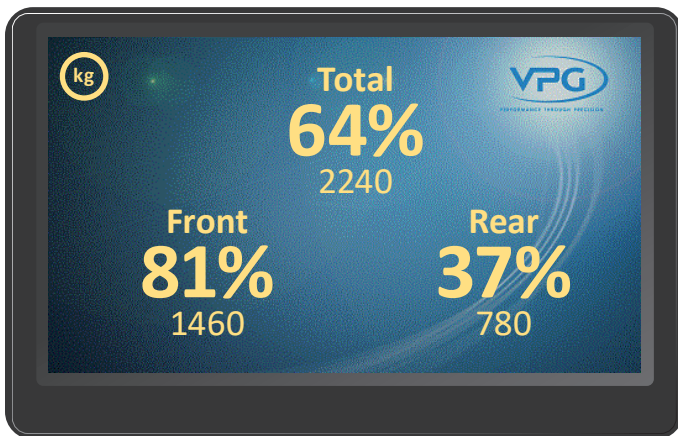

The last screen that is shown when you power down the display unit is displayed when it is powered back up.

How to navigate the system

Tap the home page screen to show the menu options:

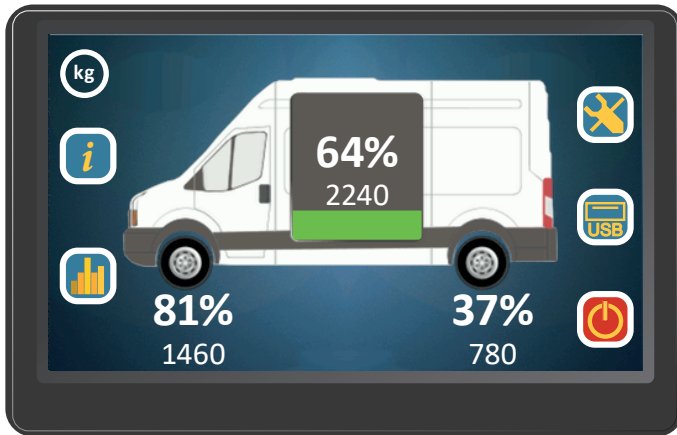

There are five home page menu options:



System info



Configuration



Diagnostics



USB



Standby - Tap to switch the display unit off

Tap a menu option to open its associated page:

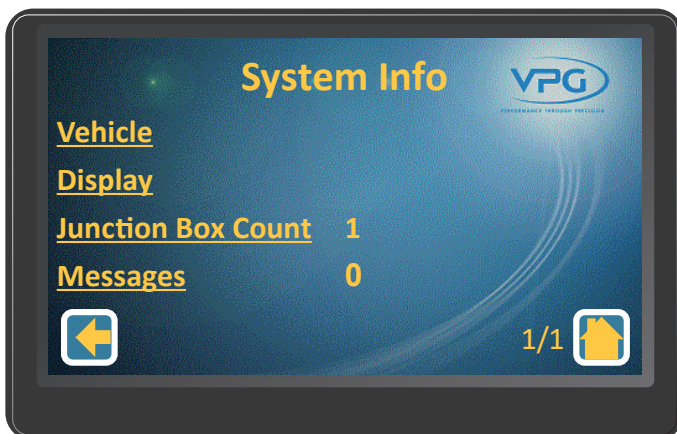

There are additional options on each page:



Tap to return to the previous page



Tap to return to the home page



Indicates the number of screens in this page. Swipe up or down to show additional screens



Underlined text indicates another menu or an editable value. Tap to access



Tap to save any changes

Editing Values

There are three methods for editing the values in the system. The appropriate method is displayed when an editable value is tapped.

Selectable options:

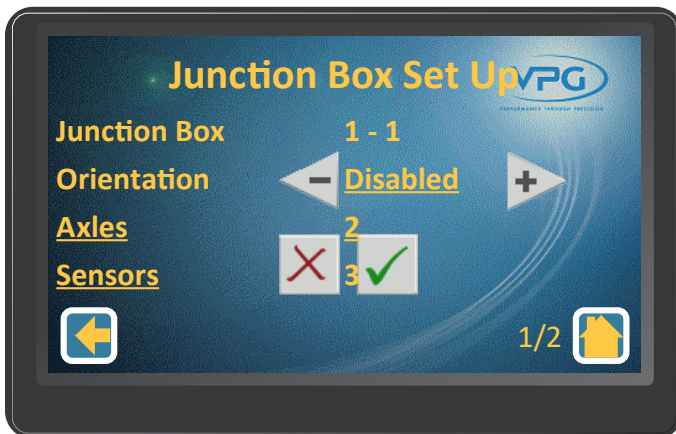

- Tap the + or - arrow to cycle through the options
- Tap the green tick to select the displayed option

Sliders:

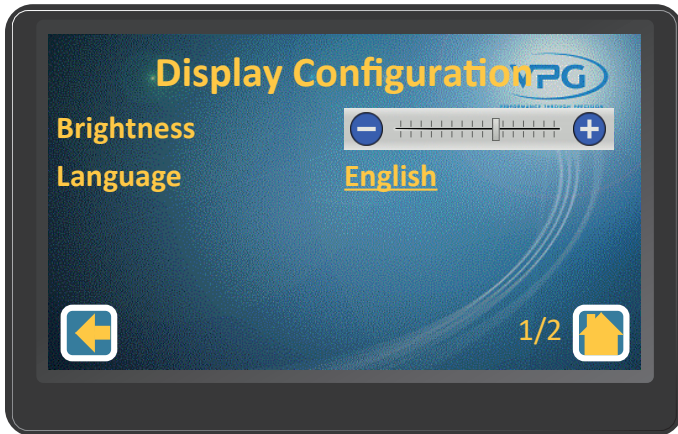

Tap the + or - icons to adjust the value up or down.

Keypad:



Tap to enter the numerical value and tap the return button to set the value

Configuration

The configuration menu

Tap the configuration icon on the home page to open the configuration menu:



There are six submenus in the configuration screen:

- **Login.** Use this option to login to the VanWeigh® system. This will allow you to edit the configuration options.
- **Vehicle Configuration.** Use this menu to input the vehicle configuration into the VanWeigh® system. This is a step by step process that allows you to configure the junction box and alarms and finally calibrate the system. The vehicle will start to display weight measurements when the calibration is complete.
- **Display.** Use this menu to configure the brightness, language, volume, date & time and power off timer settings of the display unit.
- **System Config.** Use this menu to configure any additional features, such as a serial scoreboard output.
- **Weighing Config.** Use this menu to configure the weighing units and how the weight values are displayed.
- **PIN Management.** Use this menu to edit the PIN numbers that allow access to the VanWeigh® system.

The weighing units are set to kg by default. Change this to the correct unit before configuring and calibrating the display unit, if required. See “How to configure the weighing units” on page 57

Login

Login to the VanWeigh® system to configure the system.

1. Tap the configuration icon in the home page to open the configuration menu
2. Tap login to display the keypad



3. Tap to enter the Engineer PIN number
4. Tap the return icon

Only VPG approved installers can have engineer PIN.

Vehicle configuration

1. Tap the configuration icon on the home page to open the configuration menu
2. Tap Vehicle Configuration to open the vehicle configuration menu:



The vehicle configuration is a step by step process that allows you to configure the junction box and alarms and finally calibrate the system.

The vehicle configuration menu displays the configuration settings for the junction box on the vehicle.

How to configure the junction box

The junction box is configured in the the vehicle configuration menu. From the home page, go to: Configuration > Vehicle Configuration.

1. Tap JBox Config to open the junction box setup menu:

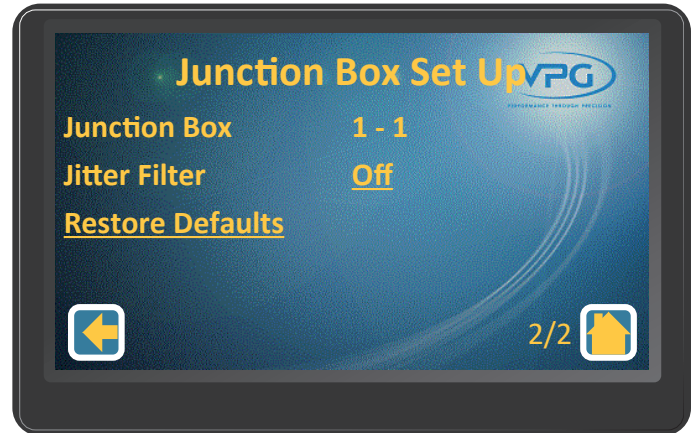
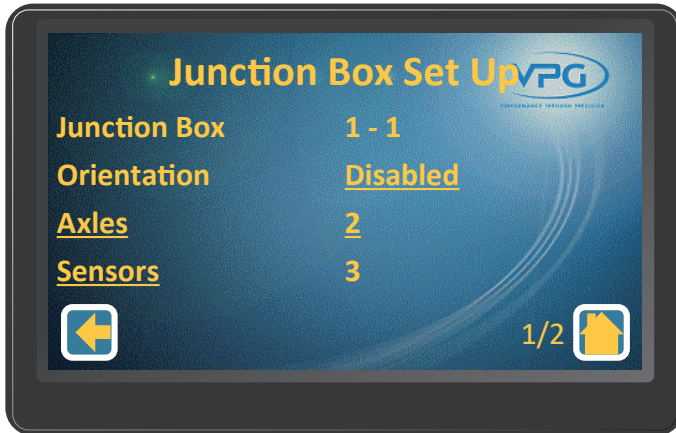

2. Tap the Orientation option
3. Select the orientation for the junction box

The junction box orientation is determined by the direction the top face of the box is facing. For example; Up, down, left side or right side of the vehicle. Please see “How to install the junction box” on page 20 for further details.

4. Tap the Axles numerical value
5. Select the number of axles that are monitored by the junction box

The junction box is able to connect to 4 sensors on the vehicle, over 2 axles.

6. Tap Axles. A message box is displayed saying 'Settings have changed - Send to Jbox (Yes) - Dicard changes (No)'.
7. Tap Yes to update. The axle set up menu is displayed:

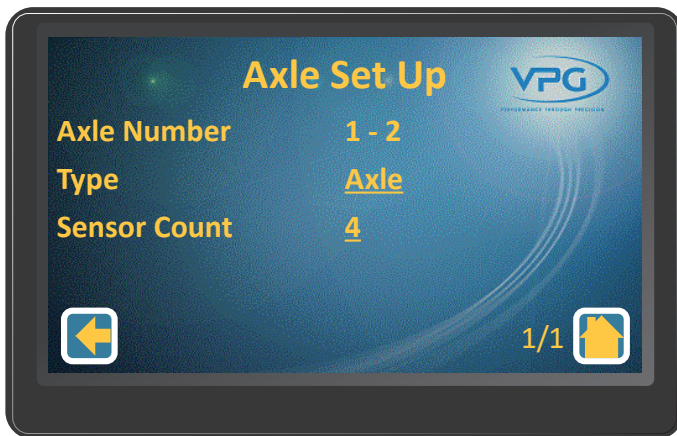

8. Swipe left or right to select an axle to configure. 1-2 is the Front Axle and 2-2 is the rear axle.
9. Tap to set the type of axle configuration and the sensor count that is appropriate for that axle. Select Axle. This is used to indicate that axle transducers are located on a single leaf spring axle. This type of configuration will usually have 2 sensors on each axle, one for each side of the vehicle.
10. Repeat steps 8 and 9 to configure each axle for the junction box.
11. Tap the back icon. A message box appears saying 'Send Axle Map to Jbox?'
12. Tap yes to update.
13. Tap the back icon to return to junction box setup page:

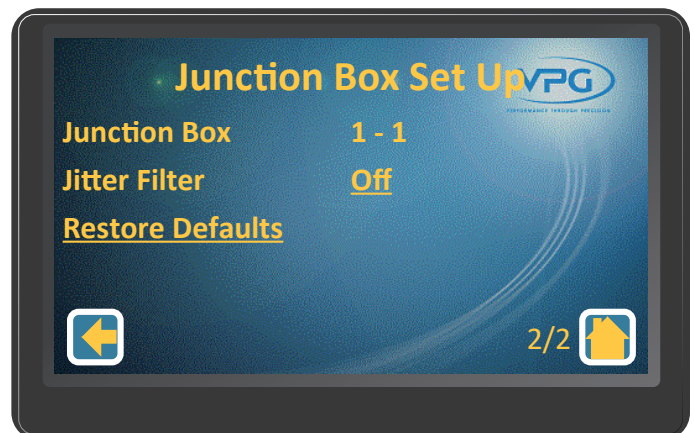
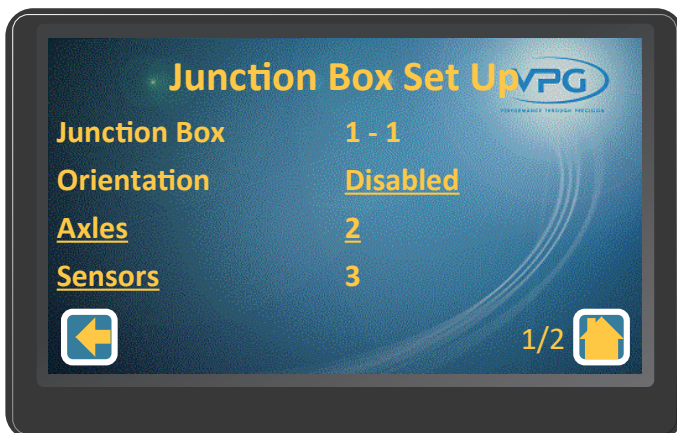

14. Tap Sensors to open the sensor set up page:



15. Swipe left or right to select a sensor to configure

16. Tap the Position value to set the position of the sensor

The position number is the position of the sensor on the vehicle. Number 1 is the sensor on the front axle, this is the sensor on the left side of the axle, 2 is the sensor on the right. 3 is the sensor on the left side of the second axle etc. See “Sensor installation positions” on page 23 for more information.

The sensors will be automatically placed in the correct position if the sensors have been connected to the corresponding labelled connection cable to the junction box. E.g. sensor on front left wheel connected to FLH label connection wire will be Sensor position 1.

17. Tap the Direction value to set the direction for sensor:

- Select Forwards if the sensor is facing the front of the vehicle
- Select Backwards if the sensor is facing the rear of the vehicle
- Select Not Applicable when the sensor is an air sensor or an axle sensor on a strut

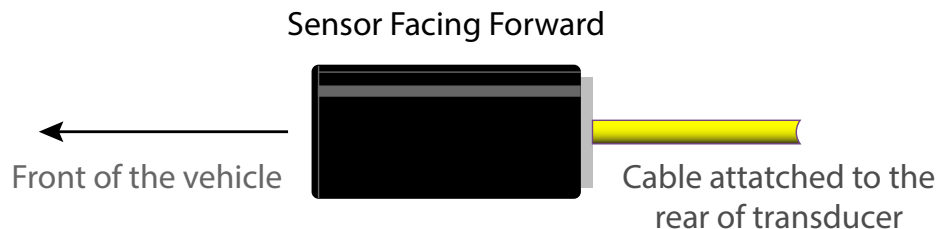

18. Repeat steps 14 -16 to configure each sensor on the vehicle.

19. Tap the back icon. A message box is displayed saying 'Update Config-Send Sensor Map to Jbox?'
20. Tap Yes to update and return to junction box setup page:

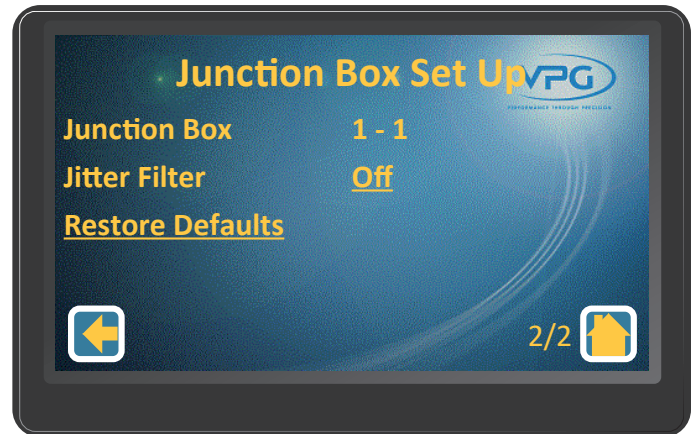
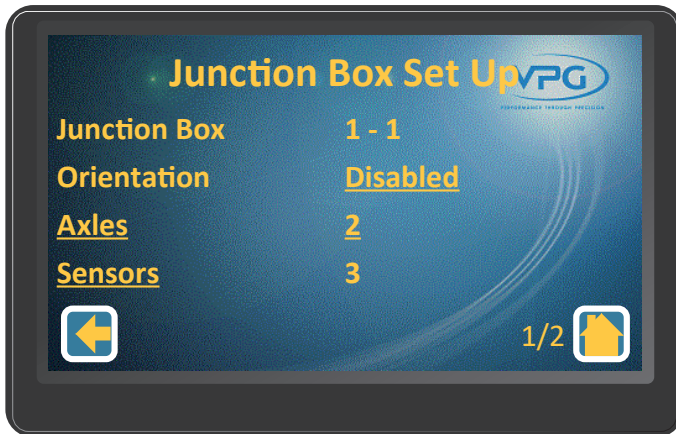

21. Tap the Jitter Filter value to set the jitter filter for the display.
22. Set the jitter filter.

The jitter filter is only required if the displayed weights fluctuate on the display unit when the vehicle is stationary. Set to off to turn the jitter filter off. Set to 1,2, or 3 to apply a stabilising filter to the data that is displayed on the home page. This should be set to the required level after the calibration is complete.

23. Tap the back icon.

If the jitter filter has been changed a message box will appear saying 'Settings have changed-Send to Jbox (Yes)-Discard changes (No)'. Tap Yes to update.

How to configure the alarms

The alarms are configured in the the vehicle configuration menu. From the home page, go to: Configuration > Vehicle Configuration.

Obtain the maximum allowable gross and axle weights from the vehicle data plate

1. Tap Alarms to open the jbox alarms config menu:

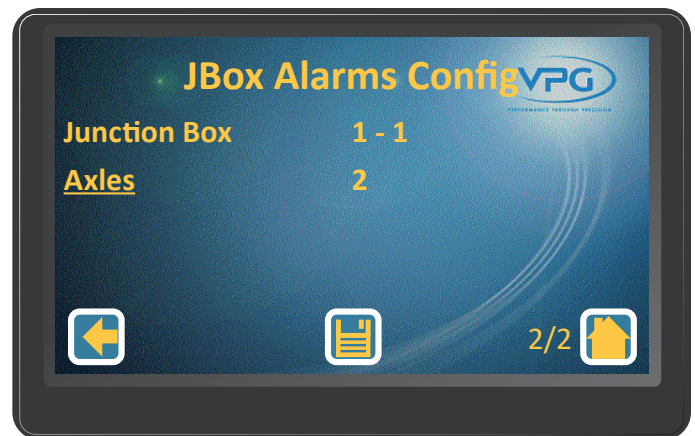

2. Tap the Gross Alarm value to set the value that will trigger the alarm when the total weight on the vehicle exceeds the maximum allowable weight
3. Tap the Enable value to enable or disable the gross alarm
4. Tap the Save icon
5. Swipe up and tap Axles to open the axle alarm config menu:



6. Swipe left or right to select the axle you want to configure
7. Tap the Alarm Weight value to set the value that will trigger the alarm when the payload on the axle exceeds the alarm weight
8. Tap the Enable value to enable or disable the axle alarm
9. Tap the Save icon. A message box is displayed saying 'Update Config - Save New Settings'
10. Tap Yes to update.

Turn the display unit off and back on if you set the alarms after the calibration is complete.

Weighing the Vehicle

Once the VanWeigh® system has been configured, it must be calibrated. This requires multiple weight measurements of the axles on the vehicle.

Ensure that you know the gross vehicle weight (GVW) before you calibrate the system

Two sets of vehicle measurements must be taken:

- Zero weights. This is the weight measurement of each axle when the vehicle is empty
 - Span weights. This is the weight measurements of each axle when the total weight of the vehicle is as close to GVW as possible
-

The zero weights calibration data should be entered into the display unit when the vehicle is empty and the zero weight measurements are taken. The span calibration data should be entered into the display unit when the vehicle is at GVW and the span weight measurements are taken. See "How to calibrate the junction box" on page 51

The weight measurements can be taken by using weigh pads or a weigh bridge.

Vehicle weighing should be performed on a flat, level surface, in calm weather conditions. If possible, weigh the vehicle indoors.

Weigh pads:

1. Use one pair of weigh pads per axle.

If possible, weigh all axle at the same time. If not, use levelling mats to maintain the overall level of any axles which are not being weighed.

2. Add together the weight measurements for both sides of the axle to calculate the current weight of the axle.



Weigh bridge:

The weigh bridge must have a level approach.

1. Drive the front axle of the vehicle on to the weighbridge
2. Take the weight measurement
3. Drive the next axle on to the weigh bridge
4. Take the weight measurement

5. Subtract the weight of the front axle from the weight of both axles to find the weight of the second axle

Repeat steps 3 - 5 if there are more than 2 axles on the vehicle until all axles have been weighed

It is recommended that you copy or recreate the zero weights and span weights tables to complete and calculate the weight values for each axle. See “Zero and span weights tables” on page 69. See below for an example of this calculation.

It is recommended that the same weighbridge is used to take all weight measurements for both the zero and span calibration processes.

Weighbridge Measurements		Weight Calculation	Axle Weight
a =	2000	Axle 1 = a	2000
b =	3500	Axle 2 = b - a	1500
c =	6000	Axle 3 = c - a	2500

The example above shows how each axle weight can be derived by subtraction using a weighbridge.

How to calibrate the junction box

Use the display unit installed in the cab to calibrate the VanWeigh® system after it has been configured.

1. Tap the configuration icon in the home page to open the configuration menu
2. Tap Vehicle Configuration to open the vehicle configuration menu
3. Tap Calibration to open the junction box calibration menu:



4. Tap the Type value to select the type of zero and span calculation to use. Select Axle to input the weight measurements of each axle. Select Wheel to input the weight measurements of each wheel.

Wheel calibration is only possible when using wheel weigh pads. For the purposes of this manual, it is assumed that the axle type is used to perform the calibration.

5. Tap Axle Zero to open the axle calibration menu

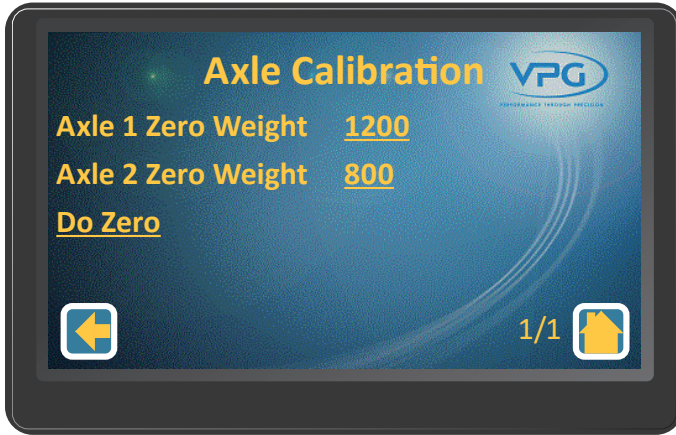

Make sure the vehicle is empty before starting the zero calibration

6. Tap the Axle 1 Zero Weight value to set the zero weight for the first axle
7. Enter the Axle 1 Zero Weight value
8. Repeat steps 6 and 7 for the next axle. Continue until the zero weights for every axle have been input
9. Tap Do Zero. A warning message is displayed
10. Tap OK to perform the zero calculation.
11. Tap the back icon to return to the junction box calibration menu

12. Tap Axle Span to open the axle calibration menu

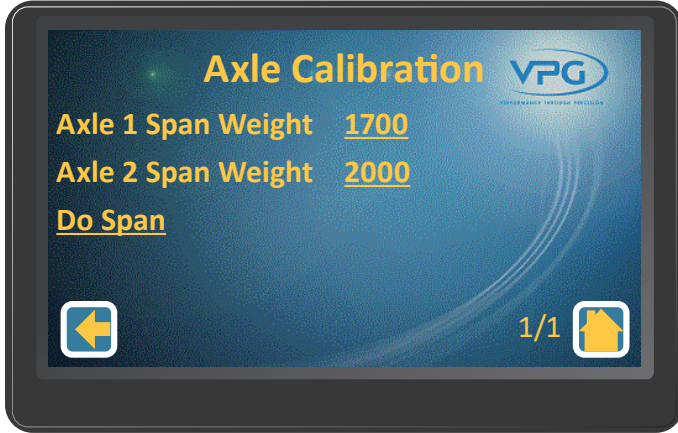

Make sure the vehicle is at GVW before starting the span calibration

13. Tap the Axle 1 Span Weight value to set the span weight for the first axle

14. Enter the Axle 1 Span Weight value

15. Repeat steps 13 and 14 for the next axle. Continue until the span weights for every axle have been input

16. Tap Do Span. A warning message is displayed

17. Tap OK to perform the span calculation.

18. Tap the home icon

19. Check that the values on the display match the span weight measurements

How to configure the display

1. Tap the configuration icon in the home page to open the configuration menu
2. Tap Display to open the display configuration menu:

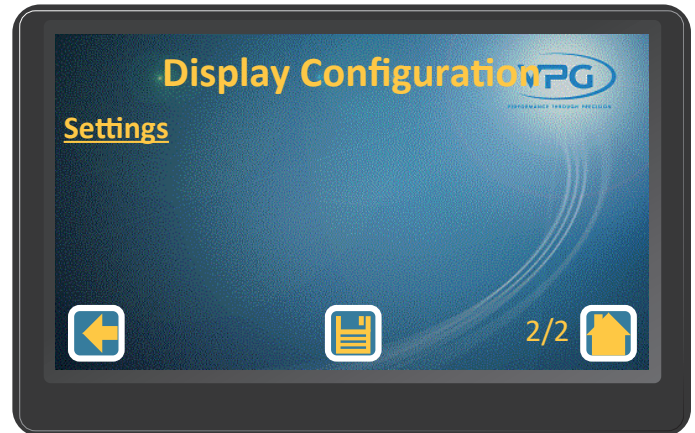
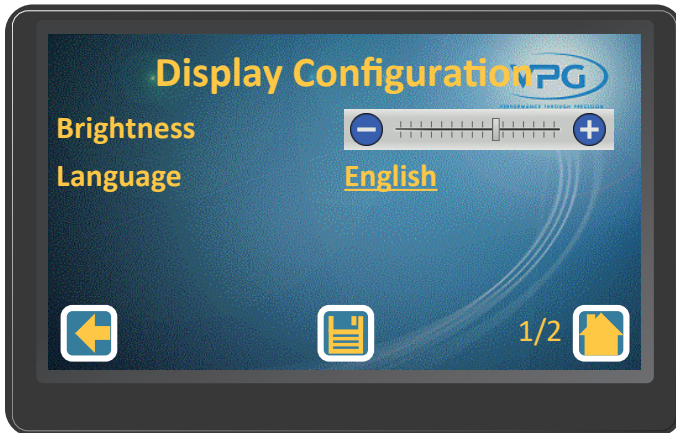

3. Tap the + or - button on the Brightness slider to increase or decrease the brightness setting
4. Tap the Language value to select the language for the display

English is the only available language on display version 02.01.04.01 and earlier

5. Tap Settings to open the display configuration settings menu

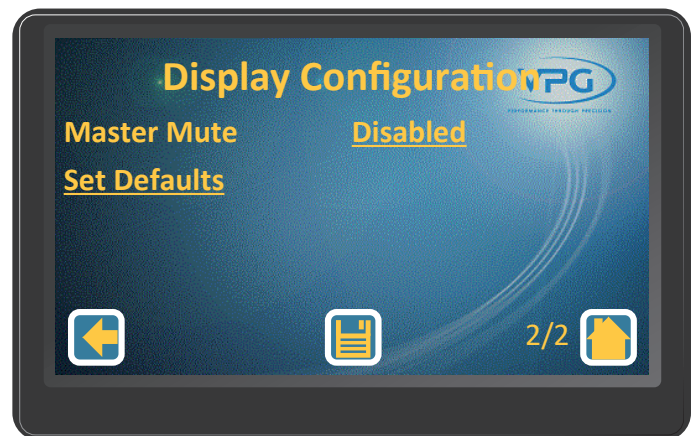
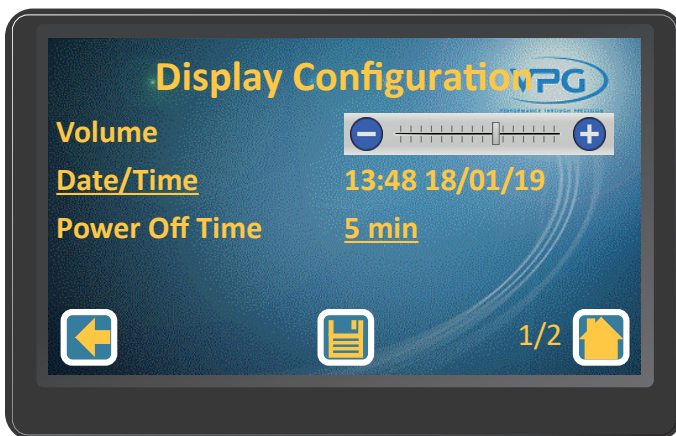

You must log in to access the display configuration settings. See “Login” on page 41 for guidance

6. Tap the + or - button on the Volume slider to increase or decrease the volume setting
7. Tap Date/Time to set the date and time
8. Tap the Power Off Time value to set the delay time before the display unit will power off
9. Tap the Master Mute value to disable or enable the master mute setting
10. Tap Set Defaults to return the display configuration settings to the default values
11. Tap the Save icon

How to configure a serial output

Printer configuration is currently not available.

1. Tap the configuration icon in the home page to open the configuration menu
2. Tap System Config to open the system config menu:

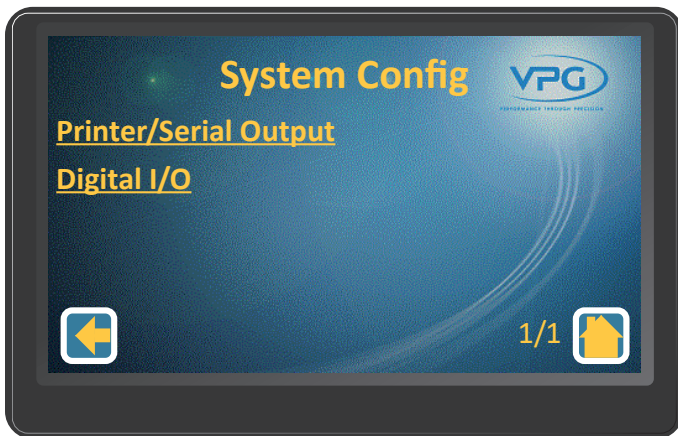

3. Tap Printer/Serial Output to open the printer and serial config page:

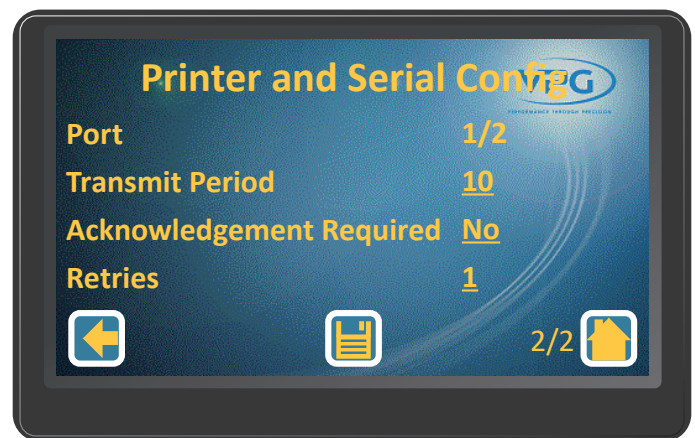
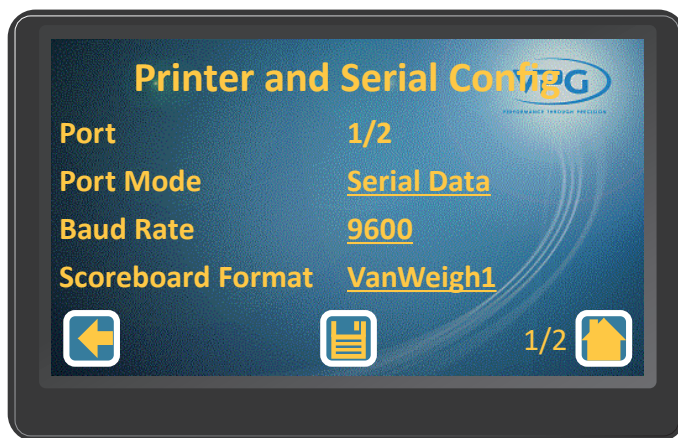

4. Swipe left or right to select the port you want to configure

5. Tap the Port Mode value to set the port mode:
 - Select Serial Data for serial output. Input the Baud Rate, Scoreboard Format, Transmit Period, Acknowledgement Required and Retries values
 - Select Printer for a printer output. Input the Baud Rate, Handshake and Print Options values
6. Tap the Save Icon

How to configure the weighing units

1. Tap the configuration icon in the home page to open the configuration menu
2. Tap Weighing Config to open the weighing config menu:

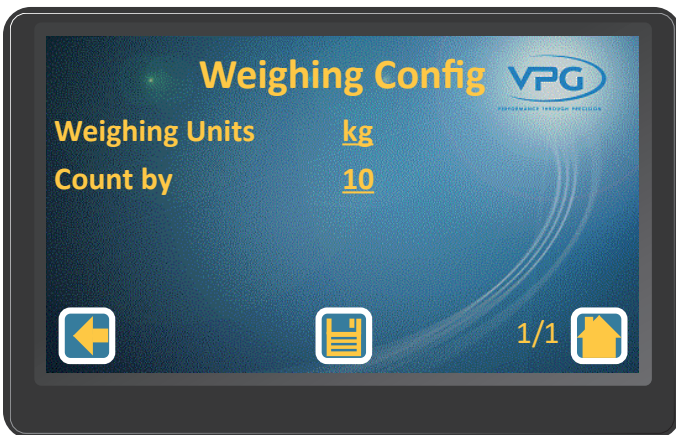

3. Tap the Weighing Units value to set the weighing units
4. Tap the Count By value to set the value that the weight measurements are rounded to when they are displayed on the monitor

It is recommended that the count by value is set to 20 kg for minimum stability

5. Tap the Save icon

How to configure the PIN Numbers

1. Tap the configuration icon in the home page to open the configuration menu
2. Tap PIN Management to open the PIN management menu:

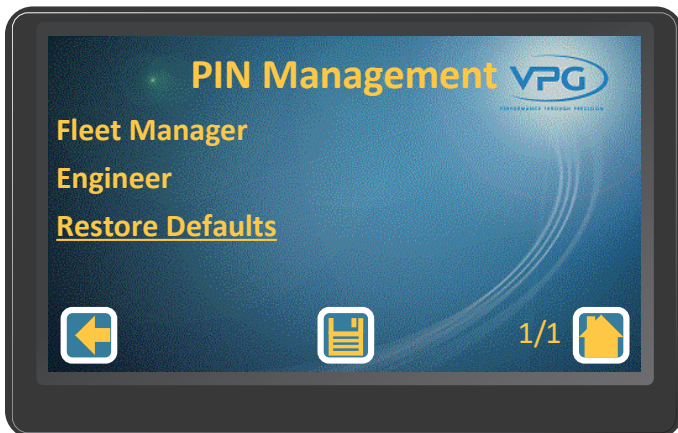

3. Tap the PIN number you want to change
4. Enter the current PIN number and tap enter
5. Enter the New PIN number and tap enter
6. Tap the Save icon

System info and Diagnostics

System Info

Tap the system info icon in the home page to open the system info menu:

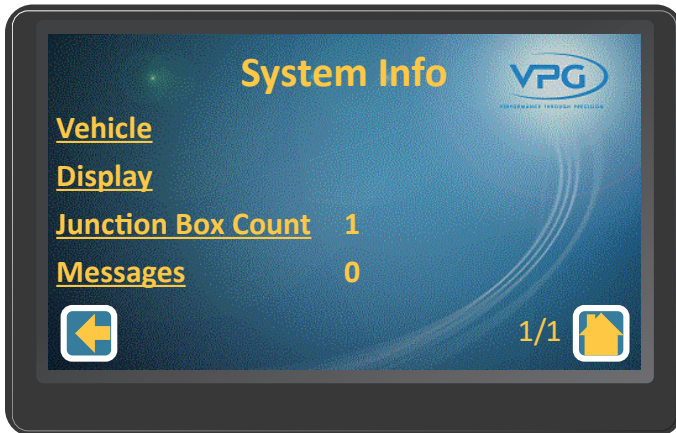

There are four submenus in the system info page:

- Vehicle. Use this menu to view information about the vehicle:



- Display. Use this menu to view information about the VanWeigh® display unit:

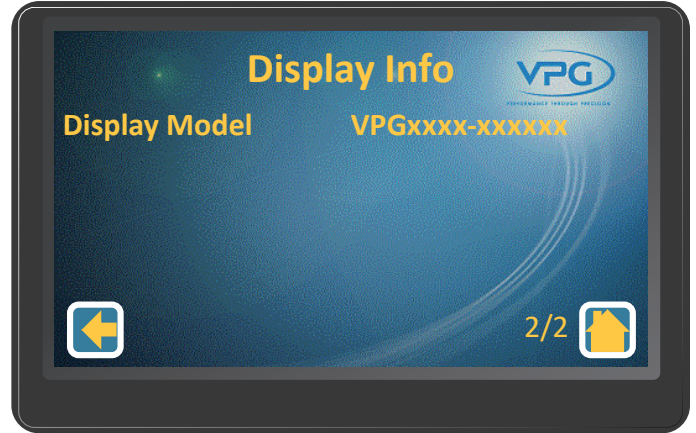
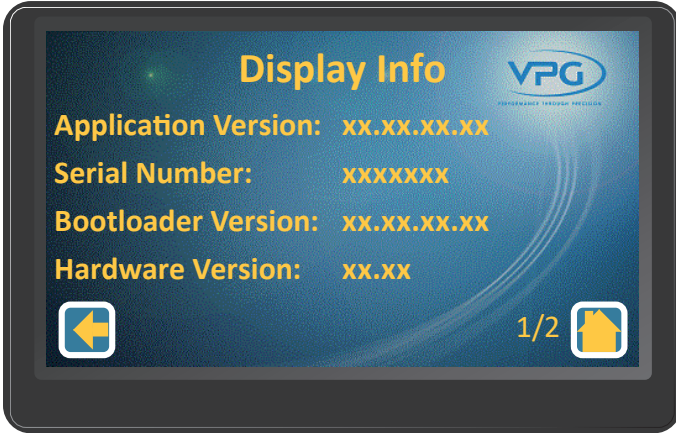

- Junction Box Count. Use this menu to view information about the junction box and its sensors:

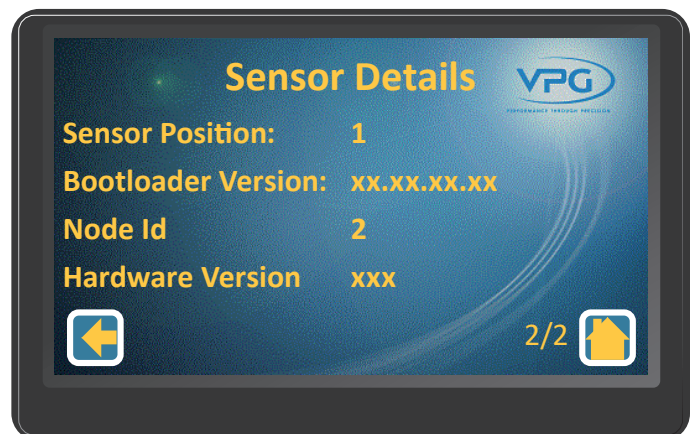
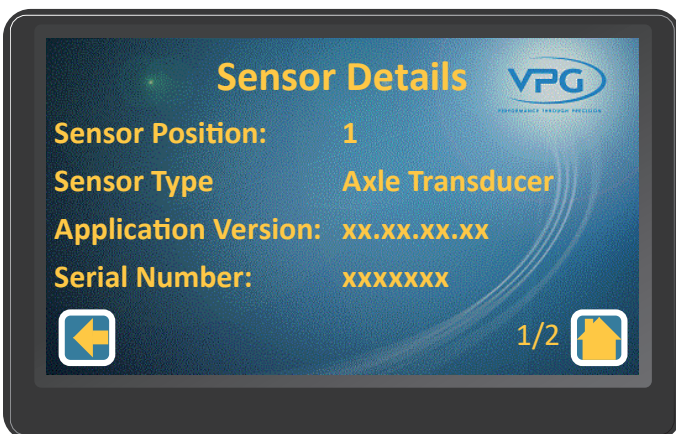
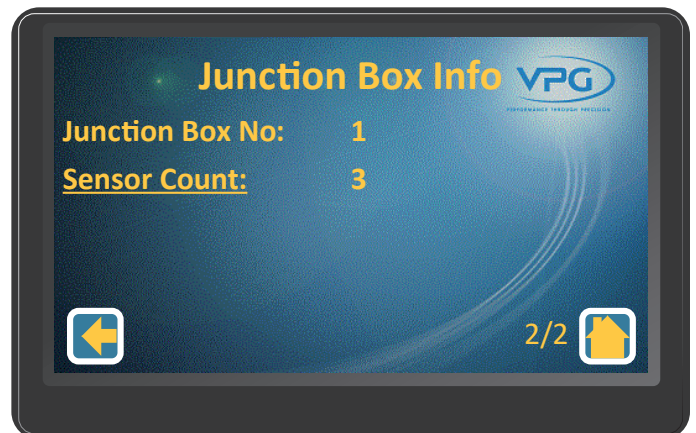
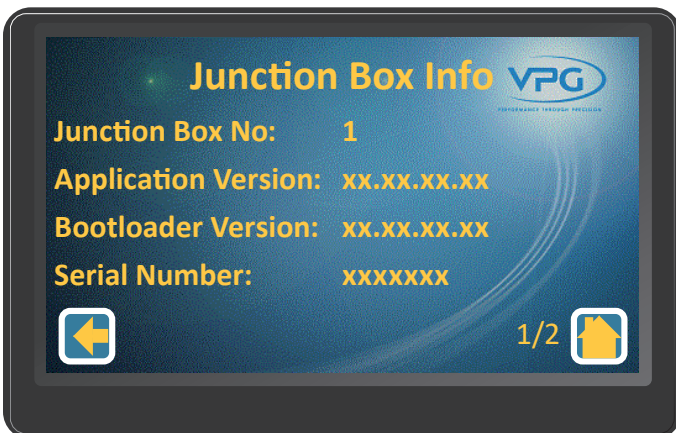

- Messages. Use this menu to view any system messages:

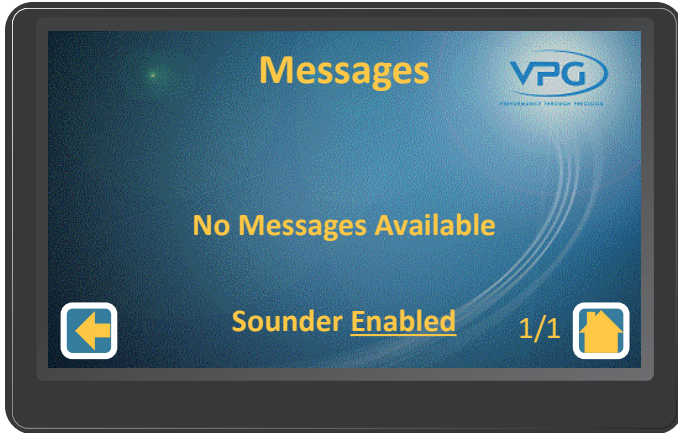

Diagnostics

Tap the diagnostics icon in the home page to open the diagnostics menu:

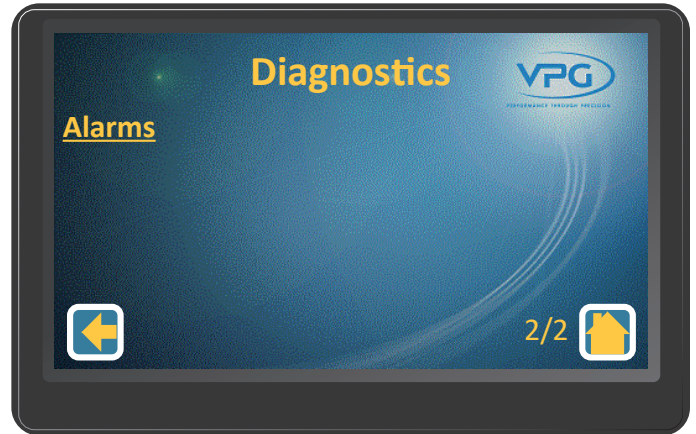
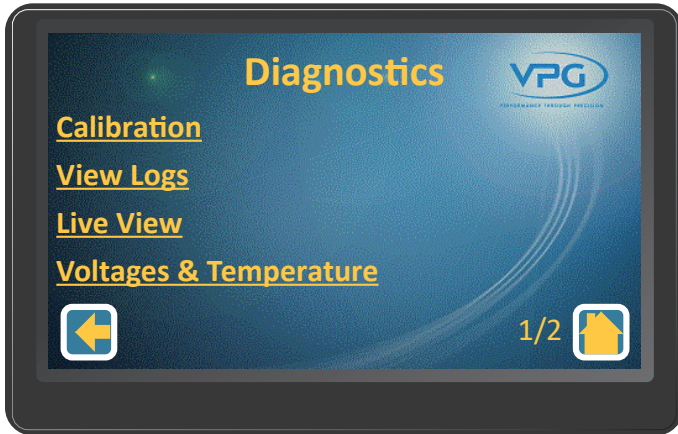

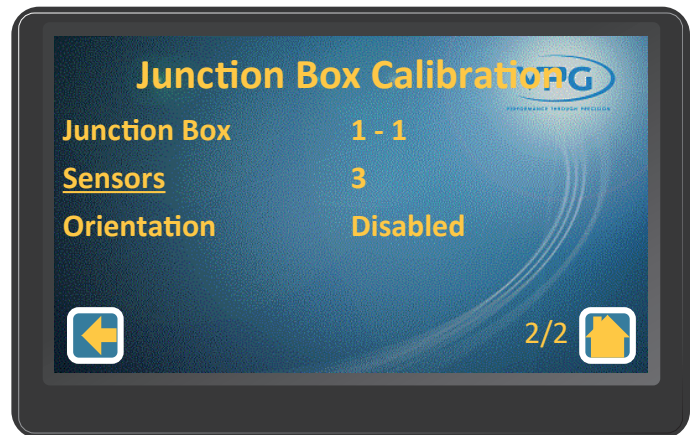

There are five submenus in the diagnostics page:

- Junction Box Calibration. Use this menu to view information about the junction box calibration, its axles and the sensors on its axles:





Axle Calibration 

Axle Number	1 - 2
Cal. Zero Weight	1200
Cal. Span Weight	1700

 1/1 



Sensor Calibration 

Sensor Position	1
Cal. Zero Weight	600
Cal. Span Weight	850
Reading at Zero	0.255124

 1/3 



Sensor Calibration 

Sensor Position	1
Reading at Span	0.55449
Reference at Zero	0.0
Reference at Span	0.0

 2/3 

Sensor Calibration 

Sensor Position	1
Gain	1253
Sensor Direction	Backwards (Cable Front)

 3/3 

- View Logs. Use this menu to View, Clear and Save the logs:

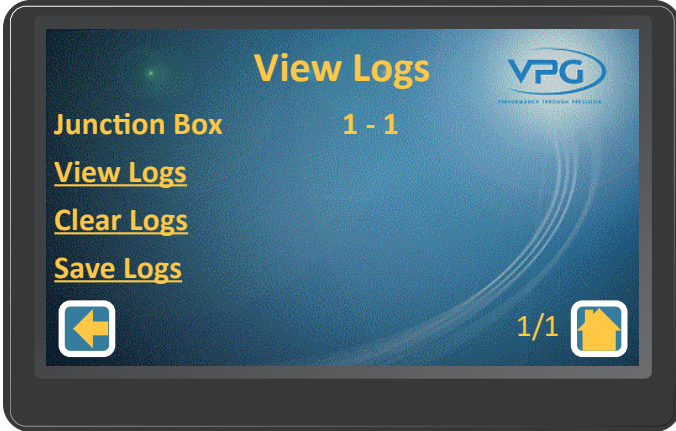

You must log in to clear logs. See “Login” on page 41 for guidance.

- Live View. Use this menu to view the live data for each sensor on the junction box:

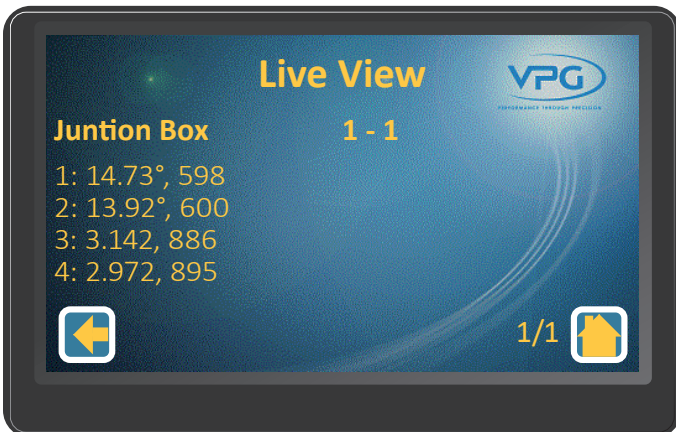

Live axle sensor values display degrees, then weight. Live air sensor values display voltage, then weight.

- Voltages and Temperature. Use this menu to view the current voltage and temperature data:

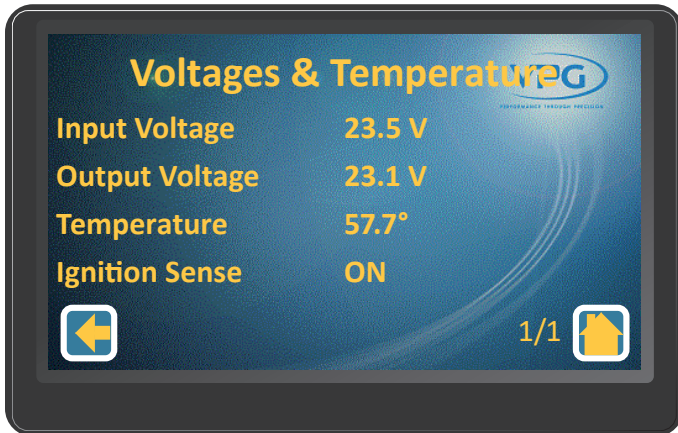

- Alarms. Use this menu to view the junction box and axle alarm settings:

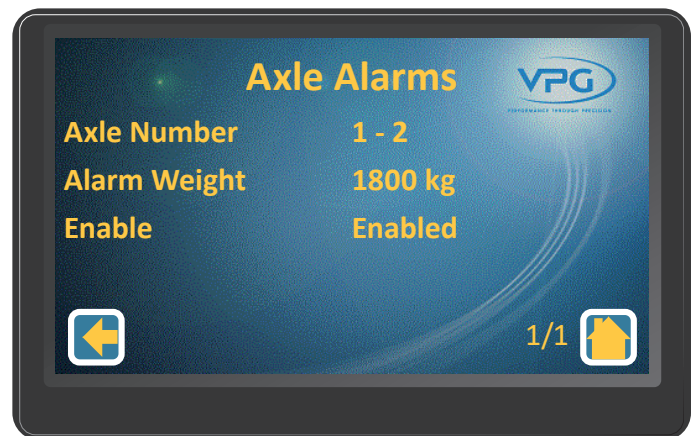
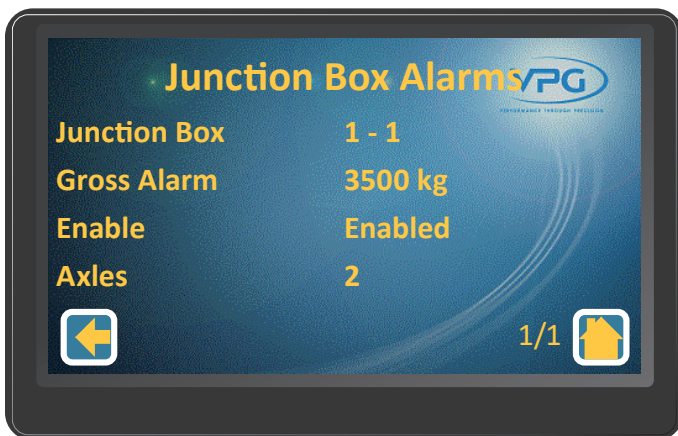

Appendix A

System configuration table

Junction box: _____

Orientation: _____

Axle		Sensors					
		Vehicle Left Side			Vehicle Right Side		
Axle No.	Type	Sensor Type	Orientation	Serial No.	Sensor Type	Orientation	Serial No.
1							
2							

It is recommended that you photocopy this table and use it to record the details of the sensors on your vehicle.

If a single sensor used to monitor both sides of an axle, enter its details in the vehicle left side columns and leave the vehicle right side columns blank.

Zero and span weights tables

Zero weights:

Weighbridge Measurements		Weight Calculation	Axle Weight
a =		Axle 1 = a	
b =		Axle 2 = b - a	

Span weights:

Weighbridge Measurements		Weight Calculation	Axle Weight
a =		Axle 1 = a	
b =		Axle 2 = b - a	

Appendix B

VanWeigh display Molex Microfit 24-way connector

Molex Microfit 24-Way connector view from front



Pin	Function	Description
1		
2		
3	RS232_1_RTS	RS232_1 Request to send - handshake
4	RS232_1_CTS	RS232_1 Clear to send - handshake
5		
6		
7	V_OUT	Output voltage to junction box
8		
9	GND	Ground to junction box
10	V_IN	Vehicle system voltage in
11	V_IG	Vehicle ignition voltage in
12	VCL_OUT	Display input voltage monitor for diagnostics
13	GND	Ground
14	GND	Ground
15	RS232_1_TX	RS232_1 Transmit
16	RS232_1_RX	RS232_1 Receive
17	RS232_2_TX	RS232_2 Transmit
18	RS232_2_RX	RS232_2 Receive
19		
20		
21	CAN_MAIN_LO	Main CAN port low output
22		
23	GND_SUPPLY	Vehicle system ground in
24	CAN_MAIN_HI	Main CAN port high output

Appendix C

VanWeigh II Specification

Axle overload protection for light commercial vehicles with a GVW of up to 7.5t (RoW), 16535lbs (US)

PARAMETRS	MINIMUM	TYPICAL	MAXIMUM	UNIT
SYSTEM				
Accuracy	Better than 2.5%			90 - 110% of Full scale
Capacity (GVW)			Up to 7.5	Tonne
			16535	lbs.
Operating voltage	9		36	VDC (US and RoW)
Operating temperature	-40		70	°C
	-40		158	°F
Current at 24V/12V (4 x transducers)			189/340	mA
Current standby at 24V/12V			3/3	mA
Weighing modes	Gross, Axles			

INDICATOR		
Type	A Si TFT RGB	
Screen Size	95.04 (W) x 53.86 (H)	
	3.74 x 2.24 (4.3 diagonal)	
Outline Dimension	105.50 (W) x 67.20 (H) x 4.20 (D)	
	4.15(W) x 2.65 (H) x 0.17 (D)	
Operating temperature	-40 to +70	
	-40 to +158	
Environmental protection	IP45	
Resolution	480x272	
Dot pitch	0.198	
	0.0078	
Signal input port	Microfit 24 way connector	
Expansion port		

PARAMETERS	MINIMUM	TYPICAL	MAXIMUM	UNIT
On screen display of weight	kg/lb.			
Overload alarm-audible	YES			
Alarm output level (at 24VDC)	≥85			dB(A)
Password protection	4 digits, engineer and manager PIN			
Load deliver capability	NO			

TRANSDUCERS

Transducer types	Up to 4 axle/air transducers			
------------------	------------------------------	--	--	--

INTERFACES

RS232				
No of ports	2			
Type	Microfit 24 way connector			
Baud rate	9600, 19200, 38400, 57600, 115200			
CAN				
YES				
No of ports	2			
Baud rate	250			KBS
DIGITAL I/O				
Inputs				
NO				
Outputs				
YES				
No of outputs	2			
Output No	1			
Type	EXT_ALM			Negative
Output No	2			
Type	EXT_AUX_OUT			Positive
Voltage	9-36			VDC
Current	1			A



ACCESSORIES AND OPTIONS

Barrier control	NO			
Printer capability	NO			
Adjustable bracket	YES			



Appendix D

Warning and Status Messages

WARNING / MESSAGE	DESCRIPTION
Initialising...	This is the first message the screen displays in the power on sequence.
Waiting for Junction boxes...	The system is searching for the junction box during the power on sequence. This message will clear once the junction box has been found.
JBox detected New Junction Box found	System has found the junction box.
Junction Box Removed	Communication lost to junction box. Check connections.
No junction box detected	Unable to detect a junction box. Check connections.
Access Denied	Pin needed.
Invalid Pin	Wrong pin number used.
Access Granted	Correct pin number used.
JBox Reset Please Wait...	System is saving settings to the junction box. Important: Do not power down when this message is displayed.
Junction Box Update Complete	Settings now saved to the junction box.
Update Config Save New Setting?	The system is asking if the new settings need to be saved. Tap Yes to save or No to revert to previous settings.
Settings Changed Continue?	The system has detected a change in the settings with no save icon tapped. Tap Yes to save or No to revert to previous settings.
Powering Down...	Ignition power has been removed and the power off timer has elapsed. System will now power down. Tap cancel to stop power down sequence. Tap OK to power down immediately or wait for system to power down automatically after 10 seconds.

WARNING / MESSAGE	DESCRIPTION
Warning Sensor Missing!	<p>System unable to find all configured sensors. Tap  icon for more information.</p> <p>Check connections.</p> <p>Note: System will continue to function, once message has been displayed, using the missing sensor's last weight reading.</p>
Warning Sensor Reboot!	<p>System has found a previously missing sensor and rebooted.</p> <p>Note: A system power cycle will be needed to clear  icon.</p>
Unknown Error	<p>General error message when system configured incorrectly.</p>
JBox Orientation Compensation Not Set	<p>Junction box orientation has been left as 'Un-configured'. Set orientation and save.</p>
Un-configured JBox Detected Axles Sensors Zero Span.	<p>Axles Sensors Zero Span. This message indicates that a junction box has been detected but the axles and sensors have not been configured, and the zero and span calibrations have not been done.</p>
Un-configured JBox Detected Zero Span.	<p>Zero Span. This message indicates that a junction box has been detected, the axles and sensors have been configured, but the zero and span calibrations have not been done.</p>
Un-configured JBox Detected Span.	<p>Span. This message indicates that a junction box has been detected, the axles and sensors have been configured and the zero calibration has been done, but the span calibration has not been done.</p>
Sensor Voltage too low	<p>Check output voltage in Diagnostics, Voltages & Temperatures, Junction Box. Output voltage should be close to 8V.</p> <p>Input voltage should be close to the vehicle supply voltage.</p>
Temperature over range	<p>Check location of junction box (too close to heat source)</p> <p>Check location of display (too close to heat source)</p>

Alarm / Warning Icons

ALARM / WARNING ICON		DESCRIPTION
	Warning Message icon	Tap icon for more information
	Alarm Sounding icon	Tap icon to mute alarm sounder
	Alarm Muted	Tap icon to unmute alarm sounder

Message/Log Error Code Text

MESSAGE / LOG ERROR TEXT	DESCRIPTION
Gross Overload	Alarm triggered when the gross weight value exceeds the set alarm value
Axle Overload	Alarm triggered when the axle weight value exceeds the set alarm value
Sensor Calibration Delta Low	The change in the sensor reading between zero and span is too small to ensure a good calibration. Note: Home screen weight/percentage readings will be extremely unstable
Sensor Calibration Opposite Delta	The left and right sensors on the axle have moved in opposite directions during the span calibration. Note: Home screen weight/percentage readings will be extremely unstable.

VPG ONBOARD WEIGHING



Contact

VPG System UK Ltd

Airedale House,

Canal Road

Bradford BD2 1AG

PH: +44 (0) 1274 771177

FAX: +44 (0) 1274 781178

E-MAIL: obw.uk@vpgsensors.com

www.vpgonboard.com

VPG Onboard Weighing

5920 S 194th Street

Kent, WA 98032

USA

PH: Toll Free 800-237-0022

or: +1-919-219-6471

E-MAIL: obw.us@vpgsensors.com

www.vpgonboard.com

vpgonboard.com

DISCLAIMER: ALL PRODUCTS, PRODUCT SPECIFICATIONS AND DATA ARE SUBJECT TO CHANGE WITHOUT NOTICE. Vishay Precision Group, Inc., its affiliates, agents, and employees, and all persons acting on its or their behalf (collectively, "VPG"), disclaim any and all liability for any errors, inaccuracies or incompleteness contained herein or in any other disclosure relating to any product. The product specifications do not expand or otherwise modify VPG's terms and conditions of purchase, including but not limited to, the warranty expressed therein. VPG makes no warranty, representation or guarantee other than as set forth in the terms and conditions of purchase. **To the maximum extent permitted by applicable law, VPG disclaims (i) any and all liability arising out of the application or use of any product, (ii) any and all liability, including without limitation special, consequential or incidental damages, and (iii) any and all implied warranties, including warranties of fitness for particular purpose, non-infringement and merchantability.** Information provided in datasheets and/or specifications may vary from actual results in different applications and performance may vary over time. Statements regarding the suitability of products for certain types of applications are based on VPG's knowledge of typical requirements that are often placed on VPG products. It is the customer's responsibility to validate that a particular product with the properties described in the product specification is suitable for use in a particular application. You should ensure you have the current version of the relevant information by contacting VPG prior to performing installation or use of the product, such as on our website at vpgsensors.com. No license, express, implied, or otherwise, to any intellectual property rights is granted by this document, or by any conduct of VPG. The products shown herein are not designed for use in life-saving or life-sustaining applications unless otherwise expressly indicated. Customers using or selling VPG products not expressly indicated for use in such applications do so entirely at their own risk and agree to fully indemnify VPG for any damages arising or resulting from such use or sale. Please contact authorized VPG personnel to obtain written terms and conditions regarding products designed for such applications. Product names and markings noted herein may be trademarks of their respective owners.