

# TruckWeigh® 1160

## Installation, Setup and Calibration Manual





## Important installation information and liability waiver

VPG designs and manufactures on-board vehicle weighing equipment. These installation guidelines are provided solely for the use of trained installers and represent the correct, safe and recommended method of installation.

These guidelines must be followed fully to ensure proper, safe installation. Failure to do so may result in serious consequences including, but not limited to, failure of the system to function properly and damage to the weighing equipment that could jeopardize the stability and safety of the vehicle.

VPG accepts no responsibility or liability for consequences arising from any improper installation of the weighing equipment including but not limited to, any misapplication or misinterpretation of the installation information contained herein.

Strict observance of these guidelines should help to ensure accurate weight measurement and enable safe operation of the vehicle. Failure of our on-board vehicle weighing equipment due to poor installation workmanship or incorrectly installed elements remains solely the responsibility of the installer.

VPG does not accept responsibility for the structural integrity of the vehicle concerned, for any part thereof, and for its proper, safe operation.

The company also reserves the right to make any amendments and alterations to this document deemed necessary. You should ensure you have the current version of this information by contacting VPG prior to performing installation, such as on our website at [www.vpgsensors.com](http://www.vpgsensors.com)

## Contents

Important installation information and liability waiver	3	Display unit operation	43
Introduction and scope	6	Action buttons	43
Introduction	6	Gross display mode	44
Scope	6	Net display mode	45
About this document	6	Axle display mode	45
Important installation information	7	Trailer display mode	46
<b>Installation</b>	<b>9</b>	Menu password	46
Components	10	<b>How to configure the weighing options</b>	<b>48</b>
Tools	17	Power on screen	48
Installation overview	18	Trailer / axle groups	50
Typical system schematics	20	Weighing units	52
Articulated vehicle	20	Count by	53
Rigid vehicles	21	Net weighing	53
How to install the junction box	22	Reading stability	54
Connecting the internal domain cable	23	<b>How to configure the system</b>	<b>56</b>
Sensor types	25	RS232 serial outputs (activate external devices)	57
Sensor installation positions	26	CAN serial output	60
Air pressure transducer	27	Vehicle ID	62
Axle transducer on a leaf spring	28	Printer	64
Axle transducer on a rear steel spring bogie (tandem axle)	29	Output settings for external devices	66
Axle transducer on a rear rubber bogie	30	Change PIN	68
Axle transducer on a front strut	31	Reset defaults	70
How to install an air pressure transducer	32	Time/date	72
How to install a steel axle transducer	35	Auto power off	73
How to install the display unit	37	<b>How to input the vehicle configuration</b>	<b>74</b>
Additional device options	40	Junction box orientation	75
<b>Configuration</b>	<b>41</b>	Axle configuration	76
Overview	42	Sensor configuration	80
		<b>How to configure alarms</b>	<b>82</b>
		Activate alarms	83
		Setting alarm weights	84
		Setting set point alarms	85
		Axle underload alarm	85
		<b>Calibration</b>	<b>87</b>
		Overview	88



Weighing the vehicle	89	Alarms and Messages	124
Weigh pads	89	Warning and Status Messages	124
Weigh bridge	89	Message Box Text and Messages	124
How to calibrate the system	91	Log Error Code Text	124
Zero calibration	92	Alarm Icons	125
Span calibration	94	<b>Appendix D</b>	<b>127</b>
<b>System options</b>	<b>99</b>	<b>TRUCKWEIGH II</b>	<b>128</b>
Overview	100	Axle Overload Protection for Larger Capacity Vehicles Greater than 7720 lbs (US), 3.5 tonne (RoW)	128
Display settings	101		
Language options	103		
Diagnostics	105		
Live view	105		
Alarms	106		
Configuration	107		
Inputs / outputs	109		
Volts / temperatures	109		
Logs	109		
System messages	111		
USB functions	112		
Update firmware	112		
Save to USB	113		
<b>Appendix A</b>	<b>115</b>		
System configuration table	116		
Zero and span weights tables	117		
Zero weights:	117		
Span weights:	118		
<b>Appendix B</b>	<b>119</b>		
1160 Back Panel D Type Connector Pinouts	120		
9 Way Male D Connector – Standard RS232 Port (DTE)	120		
25 Female D Connector – 1160 General Purpose Expansion Port	121		
<b>Appendix C</b>	<b>123</b>		

## Introduction and scope

---

Please read this installation guide completely to ensure that all instructions are fully understood before you install TruckWeigh®

---

### Introduction

TruckWeigh® is a vehicle payload optimisation, overload monitoring and load distribution system for use on vehicles with steel spring or air suspension or a combination of the two.

### Scope

This document is intended as a guide to the installation and commissioning of TruckWeigh®.

It covers two transducer types currently supported in a TruckWeigh® system:

- TruckWeigh® axle transducers. These measure suspension deflection on mechanical spring suspension systems
- Air pressure transducers. These measure changes to air pressure on air suspension systems

Different system configurations can be used to support different chassis types. The system can be configured to use either type of transducer and any combination of the two.

### About this document

Any display screenshots used in this document are intended as an illustration of the function being described. As such, any specific detail or settings shown will differ from one installation to another.

The documentation uses the following conventions:

---

Important. These are important notes and appear inside a green border

---

Caution. These notes warn of an operation which may cause damage to the TruckWeigh® system. These notes appear inside an orange border

---

**Warning. These notes warn of an operation which may cause injury to the installer. The note is highlighted in a yellow banner**

---

## Important installation information

To ensure a reliable and properly functioning system particular importance should be paid to the following:

- TruckWeigh® axle transducer installation. A suitable location for the transducer should be carefully identified and that location should then be prepared for the transducer to be attached. See “How to install a steel axle transducer” on page 35
- TruckWeigh® axle transducer orientation. Axle transducers must be mounted to the vehicle with the correct orientation. See “How to install a steel axle transducer” on page 35
- Accurate recording of sensor serial numbers in their sensor positions. It is recommended that you use the system configuration table to record this information and refer to it when you are configuring the system. See “System configuration table” on page 116



# Installation



## Components

Below is a list of components which are used in a TruckWeigh® installation.

Check that you have all of the appropriate components for your installation before starting.

### TruckWeigh® Display Unit

A single TruckWeigh® display unit is supplied for the vehicle



### Display Cage

A single display mounting cage is supplied for the display unit



### Axle Transducer

A single cable with a connector at one end and the axle transducer at the other

This is supplied for steel axle suspension systems.

A single transducer is supplied for each transducer position. See "Sensor installation positions" on page 26.

Bonding tape is supplied for each transducer



Air Pressure Transducer and Internal domain cable with Air Pressure Brass Fitting

The parts for the air pressure transducer are supplied in a bag. A single air transducer is made up from a T-connector, a brass sensor fitting and two plastic air pipe fittings

This is supplied for air suspension systems

A single transducer and a single transducer cable is supplied for each transducer position. See "Sensor installation positions" on page 26.



## Junction Box

A single junction is supplied for the rigid vehicle or tractor unit  
Additional junction boxes are supplied for each trailer unit



## Internal Domain Junction Box Cable

The cable is identified by the grey junction box connectors



## Internal Domain Junction Box Cable 2 way

The cable is identified by the grey junction box connector and 2 male internal domain cable connectors



Internal Domain Extension Cable

These cables are used to connect sensors together

The cable is identified by the grey cable connectors



Internal Cable with Y-Splitter

A single internal domain cable with y-splitter is supplied for each transducer

The cable is identified by a single female internal domain cable connector and two male internal domain cable connectors



External Domain Junction Box Cable

A single external domain output cable is supplied for each junction box

The cable is identified by the black junction box connector at one end and the external domain cable connector at the other



## External Domain Junction Box CAN Cable, Cable Onput and Output

The cable is identified by the black junction box connector at one end and two external domain cable connectors at the other, one for input and one for output



## External domain cable

A single external domain cable is supplied for the system

The cable is identified by the external domain cable connector at one end and the display connector at the other



## Power Cable

A single power cable is supplied for the display unit





Tractor Suzi



Trailer Suzi



Rigid Suzi



<p>Double Ended Suzi</p>	
<p>Cable Protector and Cable Ties Cable protector is supplied and can be cut as required Cable ties are also supplied</p>	
<p>Surface Cleaning Wipes</p>	
<p>Double Sided Bonding Tape</p>	

## Tools

Check that you have the following tools before starting an installation.

Tool	Check
Screwdriver set	
Hex driver set	
Torx driver set	
Socket set	
Multimeter	
Side cutters	
Drill set	
G-Clamp	
Spanner set (including 18 mm and 24 mm)	
Air pipe cutters	

## Installation overview

**Ensure the engine of the vehicle is off and the parking brake is applied before starting the installation**

It is recommended that you use a mechanics pit inside a workshop to install the TruckWeigh® system

The TruckWeigh® display unit is used to display sensor information once the system has been installed, configured and calibrated.

The display unit is connected to the external domain cable. The external domain is a series of junction boxes connected together. One junction box is installed on the chassis of the vehicle. One junction box is also installed on the chassis of each trailer unit.

Each junction box is connected to an internal domain. The internal domain is a series of sensors connected together. Multiple sensors are used to send information back to the junction box via the internal domain cable. The junction box then transmits information back to the display unit via the external domain cable.

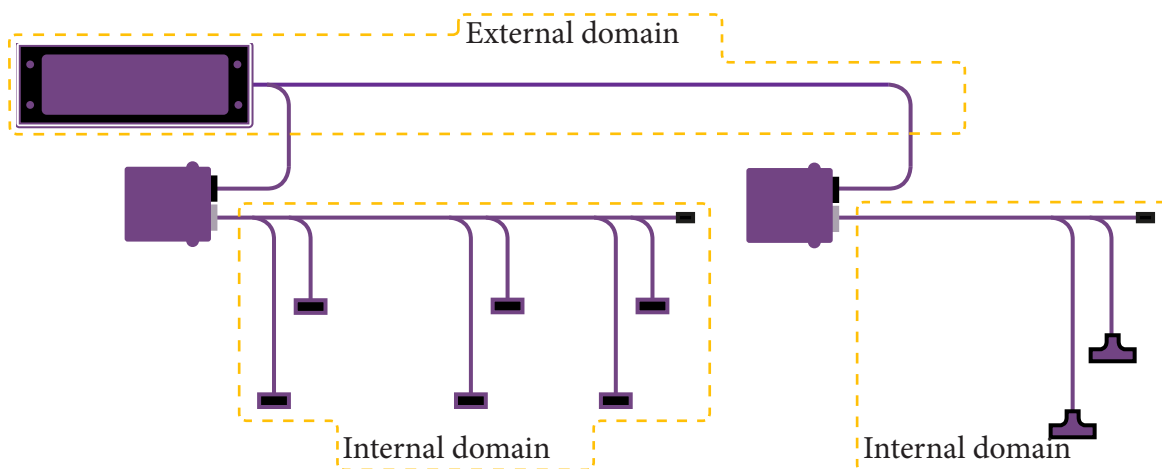

There are three main steps to installing the TruckWeigh® system:

- Junction box installation. This must be installed on the chassis of the vehicle. It must be located in an appropriate position between the suspension systems and the cab of the vehicle. The internal domain cable must be routed to each sensor position.
- Sensor installation. The type of sensors you install will depend on the suspension systems in operation on the vehicle. Air pressure transducers are installed on air suspension systems. Axle transducers are installed on steel axle suspension systems. The sensors must be installed in an appropriate position on the suspension system and linked to the junction box with the internal domain cables.
- Install the display unit. The display unit must be installed in the cab of the vehicle. It must be linked to the junction box with the external domain cable and connected to the vehicles power supply. See "How to install the display unit" on page 37.

---

It is recommended that the junction box is installed first, followed by the sensors and the display unit. However, these steps can be performed in any order.

---



## Typical system schematics

Below are two examples of system schematics showing where junction boxes and transducers are fitted in relation to the vehicle.

These are two example schematics, but a variety of configurations may be used.

A single junction box is required for a single chassis. Rigid vehicles will only require one junction box. Articulated vehicles will require a junction box for the tractor and a junction box for every trailer

### Articulated vehicle

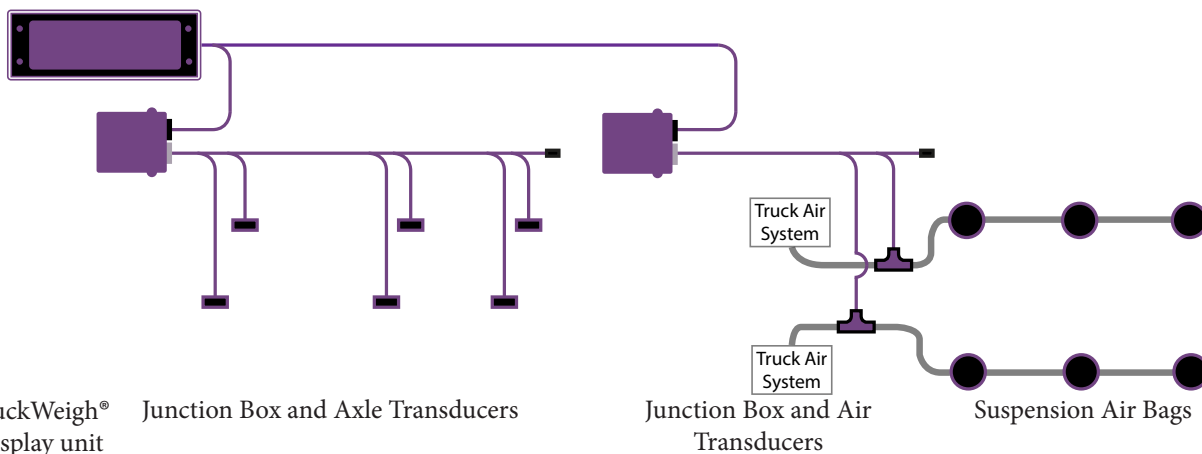
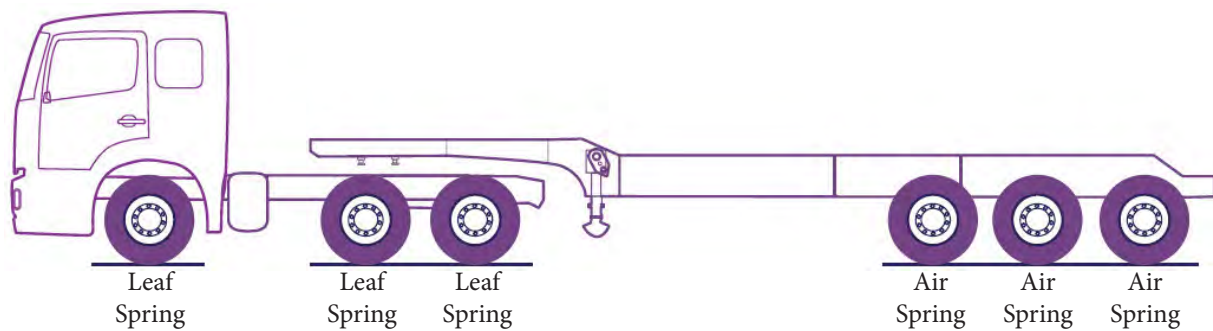

## Rigid vehicles

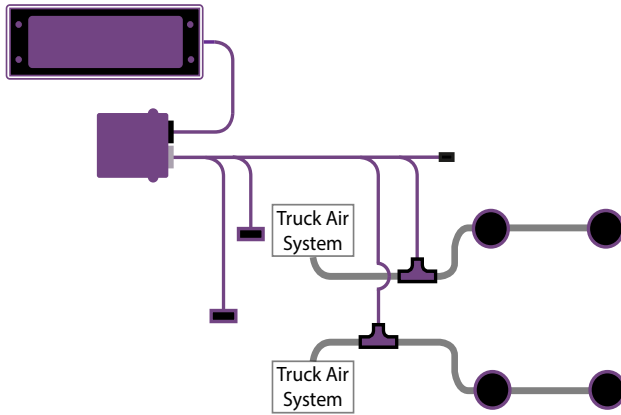
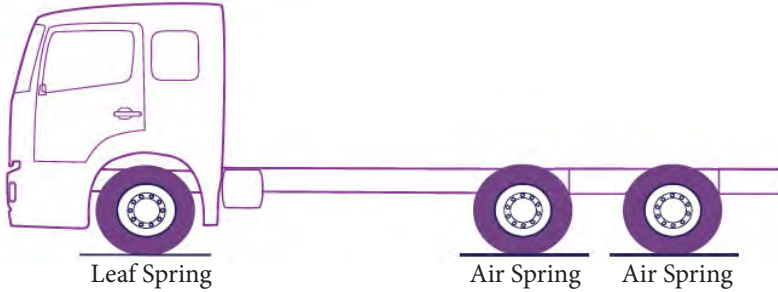

TruckWeigh® Junction Box and Display unit      Air Transducers      Suspension Air Bags

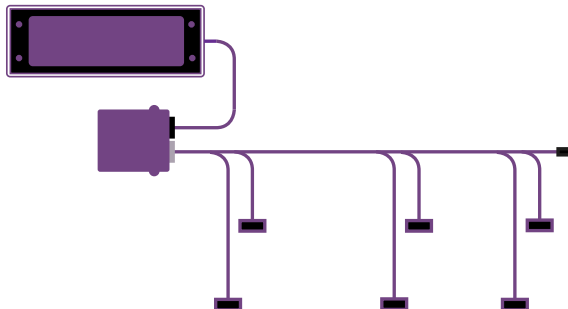
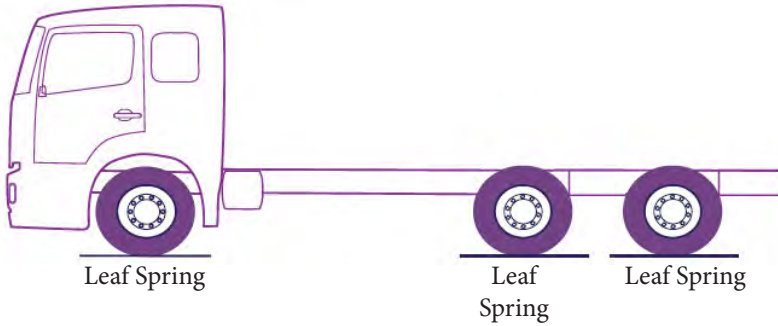

TruckWeigh® Junction Box and Display unit      Axle Transducers

## How to install the junction box

A single junction box is used to receive information from each sensor in a suspension system.

1. Select a position to install the junction box where:

- The junction box cannot be damaged by any moving parts on the vehicle
- The internal domain cable can reach from the junction box to the first transducer. Ensure the internal domain cable can be routed to the transducer without risk of damage from any moving parts
- The external domain cable can reach from the junction box to the cab of the vehicle. Ensure the external domain cable can be routed to the cab without risk of damage from any moving parts

2. Mount the junction box to the vehicle:

- The cable sockets must point to the rear of the vehicle

---

The TruckWeigh® system will not provide the correct measurements if the junction box is not mounted with the cable sockets pointing to the rear of the vehicle

---

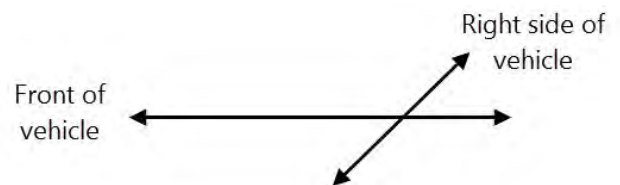

- Use existing holes on the chassis to mount the junction box, if possible. Drill holes appropriate to the size and length of the mounting screws if existing holes are not suitable
- Use 2 X 1/4" or M6 screws with Nyloc nuts to mount the junction box. The length of the screws may vary depending on where you mount it

3. Make a note of the orientation of the top face of the junction box, e.g. facing up, down, left or right side of the vehicle. In the example shown above, the junction box is oriented to the left side of the vehicle

---

It is recommended that you use the system configuration table to record this information. See "System configuration table" on page 116

---

## Connecting the internal domain cable

The junction box has two ports. These are keyed to ensure that only the correct cables can be connected to the correct port:

- A type key (Grey port). This is the connection for the internal domain cable. Sensor information is transmitted from the sensors to the junction box via this port.
- B type key (Black port). This is the connection for the external domain cable.

The internal domain cable starts at the junction box and uses y-splitters to connect to the sensors. This forms a single multi drop connection to each sensor on the vehicle.

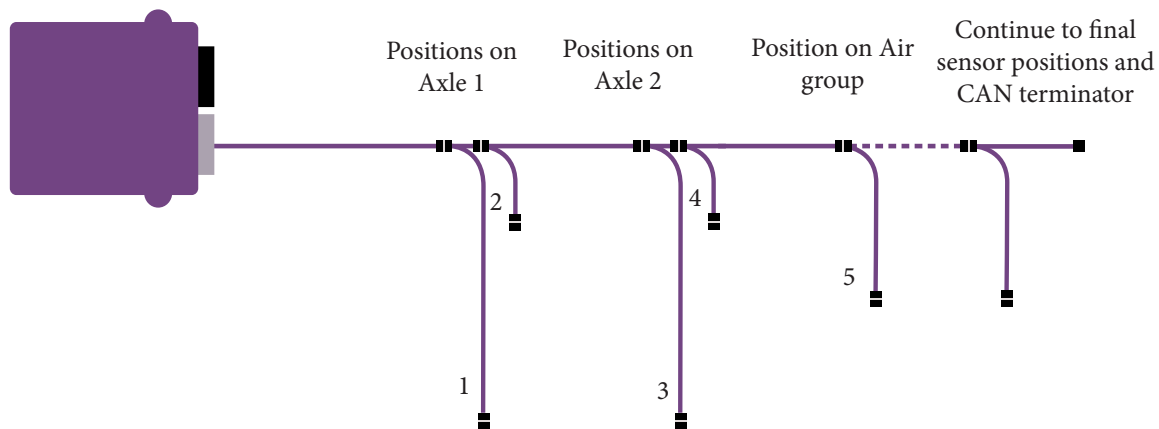

1. Connect the grey plug on the sensor input cable to the grey port on the junction box
2. Route the cable to the first sensor at the front of the vehicle:
  - Avoid running cables on or near sharp objects
  - Keep cables away from hot components such as exhausts and engines

---

Use cable protector to protect the cable at positions where it may be exposed to damage

---

3. Use a Y-splitter cable to connect to the first sensor and continue the chain
  - Mark the position number 1 on the connection to the first sensor

#### 4. Route the internal domain cable to each sensor position on the vehicle in turn:

- Use a Y-splitter cable at each sensor position to connect the sensor and continue to the next sensor. Use a CAN terminator after the final sensor to complete the cable .
- Mark the position number on the connection to each sensor
- Avoid running cables on or near sharp objects
- Keep cables away from hot components such as exhausts and engines

---

Use cable protector to protect the cable at positions where it may be exposed to damage

---

#### 5. Secure any excess cable to the chassis of the vehicle

- Use cable ties to support any cable connections. Secure the connectors to existing cables where possible
- Loop excess cable together and use cable ties to secure it to the vehicle. Secure against existing cables where possible.

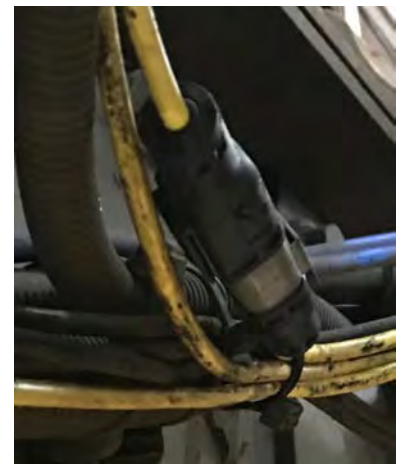

## Sensor types

Install the appropriate type of sensors on the suspension system of each wheel. There are two types of sensor:

- Air pressure transducer. This type of sensor can be mounted on air suspension systems
- Axle transducer. This type of sensor can be mounted on steel axle suspension systems. This includes:
  - Single axle leaf springs
  - Rear steel spring bogie
  - Rear rubber bogie
  - Front strut type suspension

## Sensor installation positions

The first step to sensor installation is to select the appropriate position to install each type of sensor on the vehicle.

Each sensor has a serial number. Make a note of the serial number of each sensor which you install, its position number and where it is installed on the vehicle. It is recommended that you use the system configuration table to record this information and refer to it when you are configuring the system. See "System configuration table" on page 116

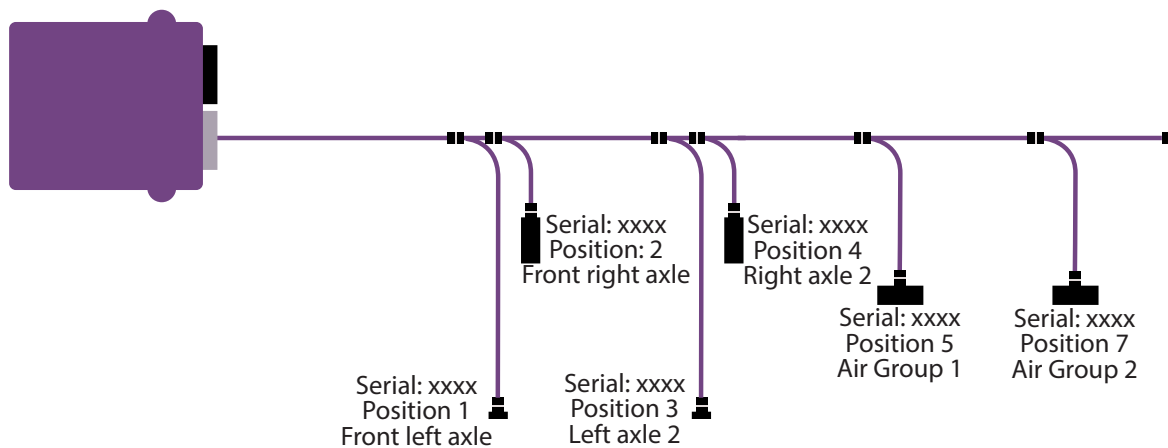

## Air pressure transducer

Select a position to install the transducer in an air circuit where:

- The transducer is between the self levelling valve and the air bellows
- The air transducer can be supported without risk of damage from any moving parts
- The internal domain cable can be routed and connected without risk of damage from any moving parts

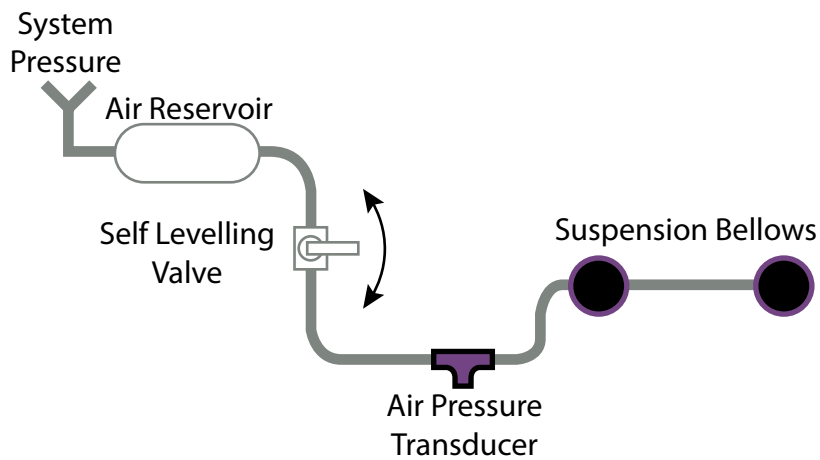



## Axle transducer on a leaf spring

Select a position to install the transducer on a single axle leaf spring where:

- The transducer is mounted to the top side of the spring
- The transducer is parallel to the orientation of the chassis
- The transducer is as far as possible from the axle. It can be mounted to the front or rear of the spring with the internal domain cable running away from the axle
- The transducer is not at risk of damage from any part on the vehicle throughout the full range of movement of the spring
- The internal domain cable can be routed and connected without risk of damage from any moving parts and allowing for the full range of movement of the transducer on the spring



---

When mounting the sensor, ensure it is in the correct orientation, with the groove at the top. See "How to install a steel axle transducer" on page 35 for further guidance

---

## Axle transducer on a rear steel spring bogie (tandem axle)

Select a position to install the transducer on a rear steel spring bogie where:

- The transducer is mounted to the under side of the spring
- The transducer is parallel to the orientation of the chassis
- The transducer is as close as possible to the axle. Transducers can be mounted to the front and rear of the spring with the internal domain cable running away from the axle
- The transducer is not at risk of damage from any part on the vehicle throughout the full range of movement of the spring
- The internal domain cable can be routed and connected without risk of damage from any moving parts and allowing for the full range of movement of the transducer on the spring



---

When mounting the sensor, ensure it is in the correct orientation, with the groove at the top. See "How to install a steel axle transducer" on page 35 for further guidance

---

## Axle transducer on a rear rubber bogie

Select a position to install the transducer on a rear rubber bogie where:

- The transducer is mounted on the torque arm. This can be the top side, left or right side or under side of the arm
- The transducer is parallel to the orientation of the chassis
- The transducer is as close as possible to the axle with the internal domain cable running away from the axle
- The transducer is not at risk of damage from any part on the vehicle throughout the full range of movement of the arm
- The internal domain cable can be routed and connected without risk of damage from any moving parts and allowing for the full range of movement of the transducer on the arm



---

When mounting the sensor, ensure it is in the correct orientation, with the groove at the top. See "How to install a steel axle transducer" on page 35 for further guidance

---

## Axle transducer on a front strut

Select a position to install the transducer on a front strut where:

- The transducer is perpendicular to the orientation of the chassis with the internal domain cable running away from the wheel
- The transducer is not at risk of damage from any part on the vehicle throughout the full range of movement of the strut
- The internal domain cable can be routed and connected without risk of damage from any moving parts and allowing for the full range of movement of the transducer on the strut

---

When mounting the sensor, ensure it is in the correct orientation, with the groove at the top. See "How to install a steel axle transducer" on page 35 for further guidance

---



## How to install an air pressure transducer

A single air pressure transducer is used to monitor a single air circuit in an air suspension system.

For example; a single air circuit with one ride height control valve to control multiple bellows on both sides of the vehicle. In this case, a single air pressure transducer is required.

If separate air circuits are present, a transducer must be installed on each air circuit.

For example; two air circuits, One with a ride height control valve to control the bellows on the left side and one with a ride height control valve to control the bellows on the right. In this case two air pressure transducers are required, one for the circuit on the left side of the truck and one on the right.

Ensure that you select the appropriate position for the sensor. Please see "Sensor installation positions" on page 26 for guidance on selecting a position for a sensor

1. Build the air pressure transducer:
  - i. Disconnect the fitting from the internal domain cable
  - ii. Place the washer over the thread. It is tape is also applied
  - iii. Connect the sensor to the fitting. Use 18 mm and 24 mm spanners to tighten
  - iv. Remove the cap from the sensor
  - v. Connect the fitting and sensor to the T-connector. Push-fit until you hear sensor and T-connector together
  - vi. Connect the air pipe fittings to each side of the tee on the T-connector. Push-fit until you hear two clicks to lock the air pipe fitting and T-connector together

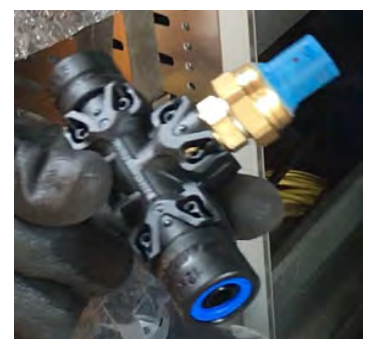
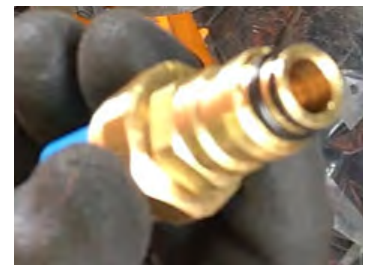
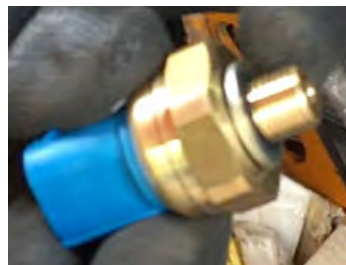
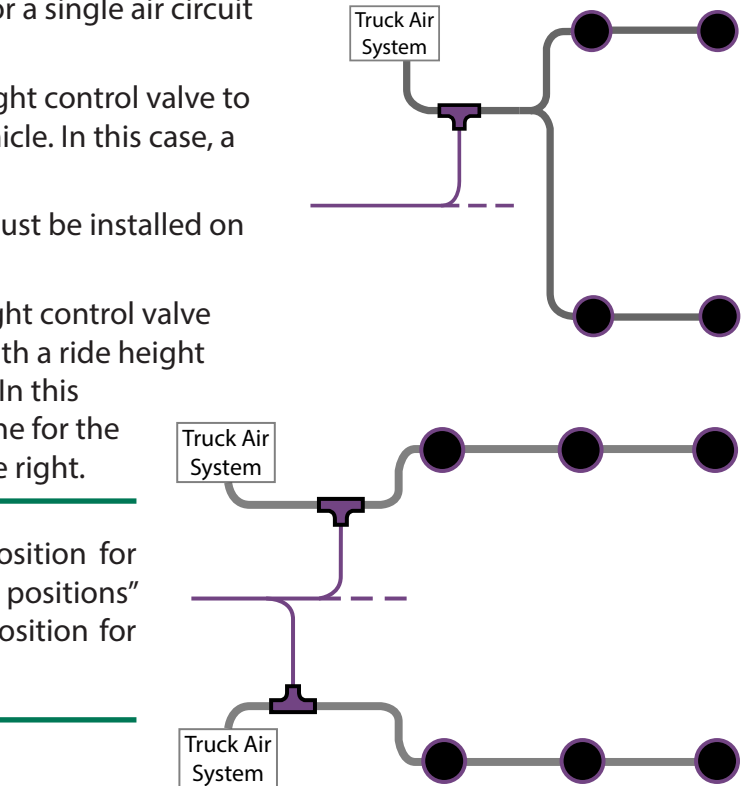

2. Depressurise the air suspension systems

**Ensure the air pressure system is fully depressurised to avoid movement in the suspension when the air pipe is cut**

3. Reconnect the sensor to the internal domain cable

It is recommended that self amalgamating tape is wrapped around the air transducer connector and a little way up the cable to provide protection



4. Cut the air pipe at the appropriate position

5. Cut 1" of pipe off the cut end of the air pipe

6. Clean any dirt from the ends of the air pipe



7. Connect the air pipe to each side of the air pressure transducer. Push-fit until you hear two clicks to lock the pipe into the pipe fittings



8. Connect the internal domain cable to the cable chain

## 9. Secure air pipe, transducer and internal domain cable to vehicle

- Use cable ties to support air pipe and sensor cable connections. Secure the connectors to existing cables where possible
- Ensure that cable to cable connections are well supported
- Avoid running cables on or near sharp objects
- Keep cables away from hot components such as exhausts and engines

---

Use cable protector to protect the cable at positions where it may be exposed to damage

---

- Use cable ties to secure any excess cable to the chassis of the vehicle

---

Ensure that you make a note of the serial number of the sensor and the location on the vehicle where it is installed.

---

## 10. Make a note of the serial number of the sensor and the position it is located on the vehicle, e.g. SN: xxxx, rear left air circuit etc.

---

It is recommended that you use the system configuration table to record this information. See "System configuration table" on page 116

---

## How to install a steel axle transducer

A single axle transducer is used to monitor a single axle suspension system. In most cases, two axle transducers will be installed per axle, one on the suspension for the left wheel, one on the right.

Ensure that you select the appropriate position for the sensor. Please see "Sensor installation positions" on page 26 for guidance on selecting a position for a sensor

1. Clean and dry the surface where the transducer will be mounted to the suspension system:

- Use brake cleaner and scotchbrite to remove heavy debris
- Use alcohol wipes provided to ensure all grease is removed



Loose paint and rust must be cleaned down to bare metal. The site must be dry before installation

2. Ensure the mounting surface is at an appropriate temperature:

- The ideal temperature of the mounting surface is 70°F / 21°C
- If required, warm the spring with a hot air gun before bonding the transducer



It is not recommended to apply the bonding tape at temperatures below 60°F / 15°C

3. Warm the bonding tape in your hands and apply it to the appropriate side of the sensor:

- The sensor must always be mounted with the face adjacent to the groove pointing up
- The sensor must always be mounted with the internal domain cable pointing towards the pivot point on the suspension system.

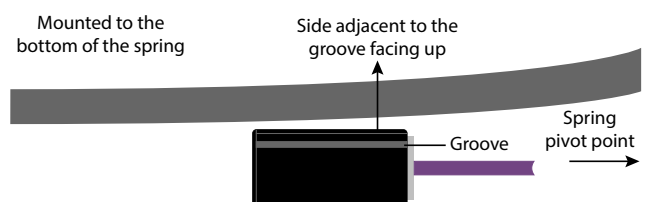
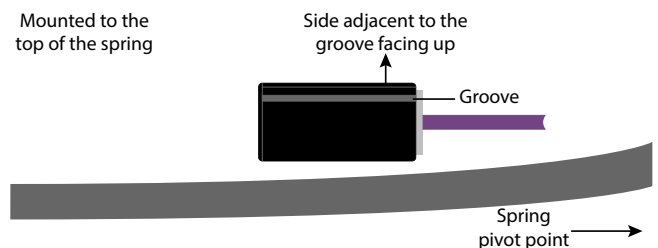

Please see "Sensor installation positions" on page 26 for further guidance on sensor orientation in specific suspension systems



4. Mount the sensor to the suspension and clamp in place for a minimum of 10 minutes
5. Connect the internal domain cable to the cable chain
  - Ensure that cable to cable connections are well supported
  - Avoid running cables on or near sharp objects
  - Keep cables away from hot components such as exhausts and engines



Use cable protector to protect the cable at positions where it may be exposed to damage

- Use cable ties to secure any excess cable to the chassis of the vehicle

Ensure that you make a note of the serial number of the sensor and the location on the vehicle where it is installed.

6. Make a note of the serial number of the sensor, the position it is located on the vehicle and the direction it is facing e.g. SN: xxxx, position 1, front right axle, facing forward
  - The internal domain cable is attached to the rear of the transducer. The opposite face is used to indicate which direction the sensor is facing

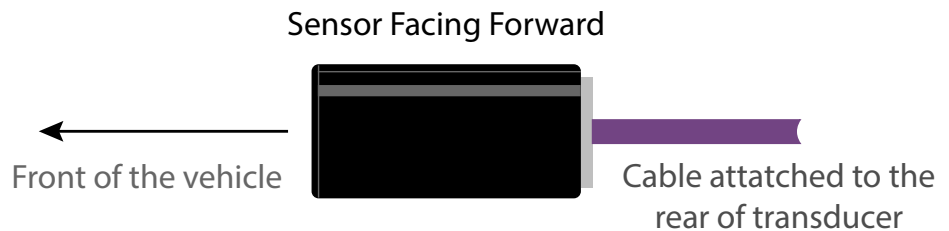

It is recommended that you use the system configuration table to record this information. See "System configuration table" on page 116

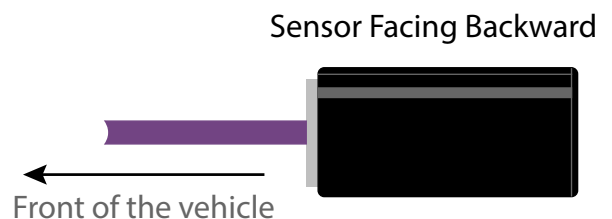

## How to install the display unit

A single display unit is installed in the cab of the vehicle to display the sensor information. It is connected to each junction box mounted on the vehicle and trailers via the external domain cable.

The junction box has two ports. These are keyed to ensure that only the correct cables can be connected to the correct port:

- A type key (Grey port). This is the connection for the internal domain cable.
- B type key (Black port). This is the connection for the external domain cable. Information is transmitted from the junction box to the display unit via this port.

The external domain cable starts at the junction box and routed to the cab of the vehicle.

1. Connect the black plug on the external domain cable to the black port on the junction box
2. Route the external domain cable to the location for the display unit in the cab of the vehicle

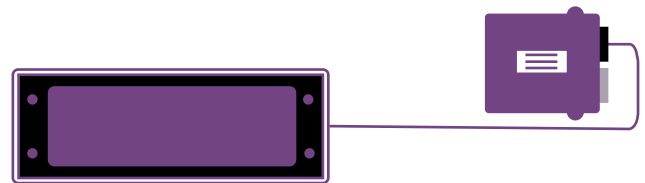

- Avoid running cables on or near sharp objects
- Keep cables away from hot components such as exhausts and engines

---

Use cable protector to protect the cable at positions where it may be exposed to damage

---

It is recommended that you follow existing cable routes and ensure that the cable is able to plug into the rear of the display unit after it has been mounted

---

3. Route the power cable from the location of the display unit in the cab to the appropriate connection point for the power supply in the vehicle

4. Connect the power cable to the connection point for the power supply in the vehicle

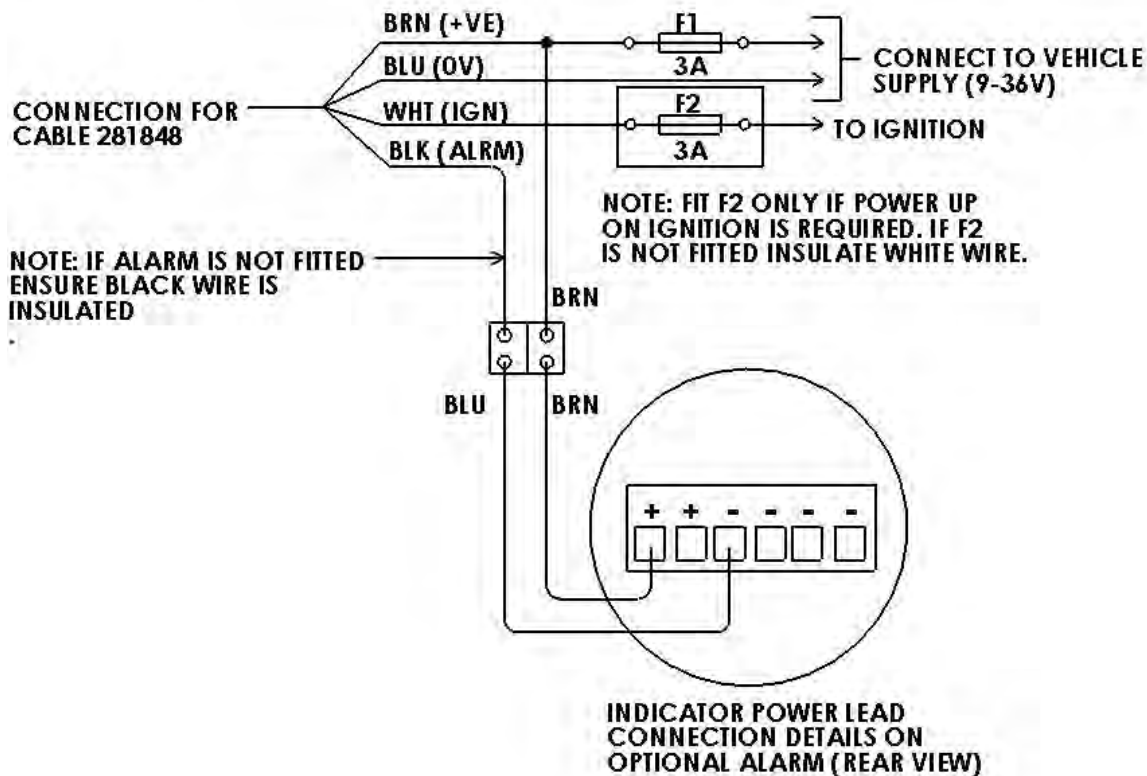

- The system can be powered from 12V or 24V DC power supplies
  - The system has an operating range of 9V to 36V DC
  - The white wire allows you to connect to the ignition if you want the monitor to power on and off with the ignition
  - The black wire allows you to connect the monitor to an alarm, if required
5. Mount the display unit:
    - Use mounting cage to mount the display unit to the DIN mount in the cab of the vehicle. Use the cage tabs to secure it in place
    - Use the dash mount to mount the display unit to another location in the vehicle. Mount it to a position which does not obscure the driver's line of sight when driving the vehicle
    - Ensure that the external domain cable and power cable are routed through the back of the display unit

6. Plug the power cable into the display unit
7. Plug the external domain cable into the display unit

---

Plug in any cables for the optional features.  
See "Additional device options" on page 40  
for further information

---

8. Test the power connection
9. Mount the display unit into the mounting cage or dashboard mount

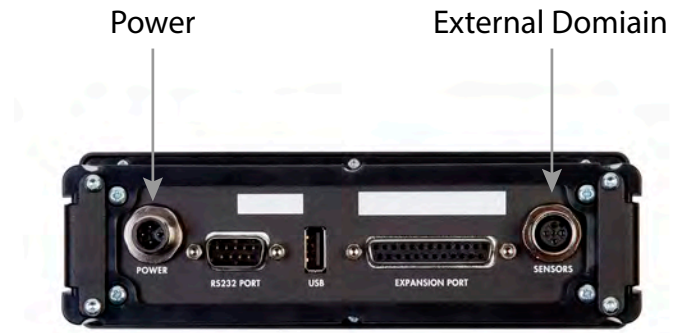

## Additional device options

The rear of the TruckWeigh® display unit provides some additional ports to use with other devices, if required.

- The 9 PIN male D type connector port can be used to connect to an on board printer in the cab of the vehicle. See “9 Way Male D Connector – Standard RS232 Port (DTE)” on page 120
- The USB port can be used to connect to a USB memory stick. This allows you to retrieve transaction data, backup your parameters and install firmware updates. See “USB functions” on page 112
- The 25 PIN female D type connector port provides digital I/O and RS232 comms for connection to alarms and telematics systems. See “25 Female D Connector – 1160 General Purpose Expansion Port” on page 121

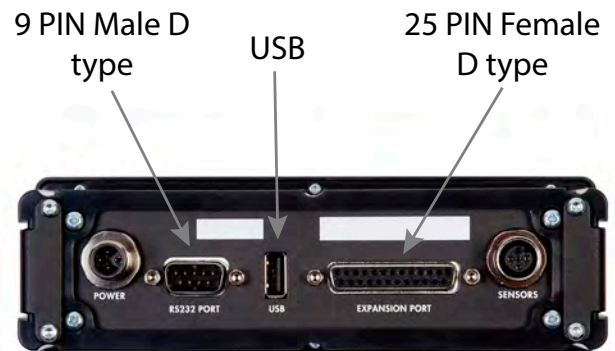

Plug any additional devices into the display unit before it is mounted to the mounting cage.

---

Please refer to the manual for the additional device for the further installation information

---

# Configuration

## Overview

The display unit is used to display the weight measurements from the sensors on the vehicle.

The display unit must be configured to display any values in the appropriate format and allow any external devices to operate. See “How to configure the weighing options” on page 48 and “How to configure the system” on page 56

The display unit will not display any weight measurements until the system has been:

- Configured to reflect the setup of the sensors and junction boxes on the vehicle. See “How to input the vehicle configuration” on page 74
- Calibrated to accurately show the weight measurements. Once the configuration is complete, see “Calibration” on page 87

The display unit will show a message to indicate the current stage of the configuration and calibration process:

- Config required. This indicates that the vehicle has not yet been configured. See “How to input the vehicle configuration” on page 74
- Zero required. This indicates that the vehicle configuration is complete, but the zero values have not been set in the calibration process
- Span required. This indicates that the vehicle configuration is complete and the zero values have been calibrated, but the span values have not been set in the calibration process.

## Display unit operation

The display unit uses capacitive touch sensor technology to operate it. There are four positions which are used to interact with the menu





Each touch pad is illuminated by LED. It can be tapped to activate the corresponding action on the screen next to it.

### Action buttons

There are several action buttons on the display. Each button will only be displayed if there is an option on the screen to use it.

 Toggle mode

 Gross display mode displayed

 Net display mode displayed

 Axle display mode displayed

 Trailer display mode displayed

 Go back

 Scroll up

 Scroll down





## Gross display mode

The gross display mode displays the current gross weight of the vehicle and provides access to the main menu.

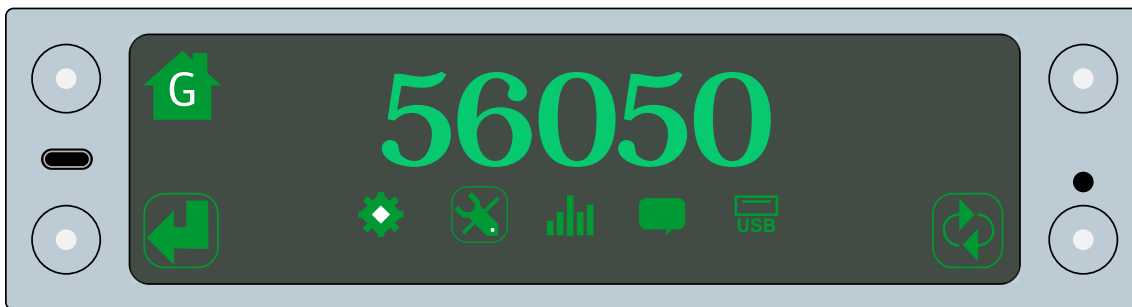

- Tap the toggle mode button to toggle between the display modes
- Tap the cycle button to cycle through the menu options. A border is displayed around an option as you cycle through the menu
- Tap the select button to select a menu option

There are five sub menus in the gross display mode:



 System Messages

 USB

---

If net weighing is activated, the gross display mode is replaced with the net display mode. See "Net weighing" on page 53

---

## Net display mode

The net display mode displays the net weight and provides access to the main menu. The net weight is the weight of the load on the vehicle

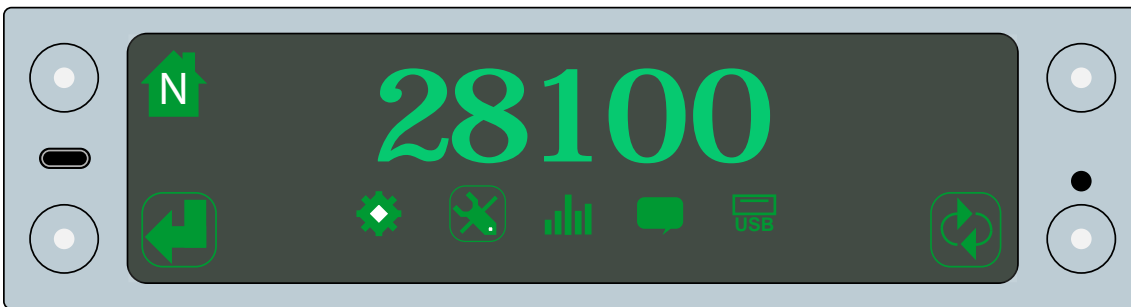

This provides access to the same menu options as the gross display mode.

## Axle display mode

The axle display mode displays the current gross or net weight of the vehicle and the weight readings of each axle or axle group.

Axles may be configured into groups for purposes of measuring the weight applied to grouped suspension systems, such as air groups or bogie axles. See "Trailer / axle groups" on page 50.

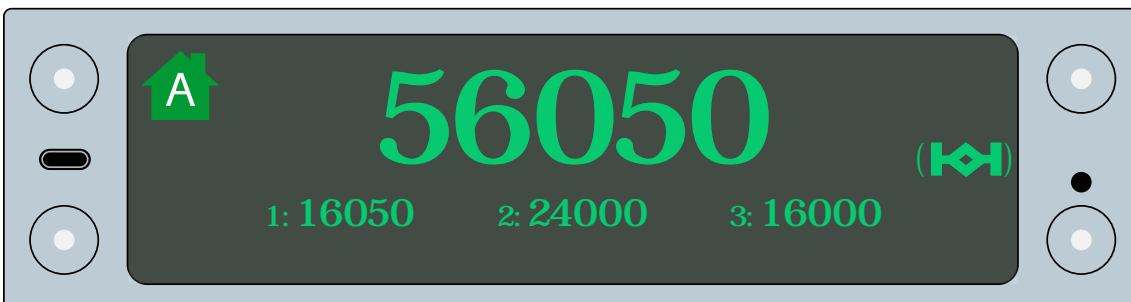

Tap the toggle mode button to toggle between the display modes

## Trailer display mode

The trailer display mode displays the current gross or net weight of the vehicle and the weight readings of each trailer.

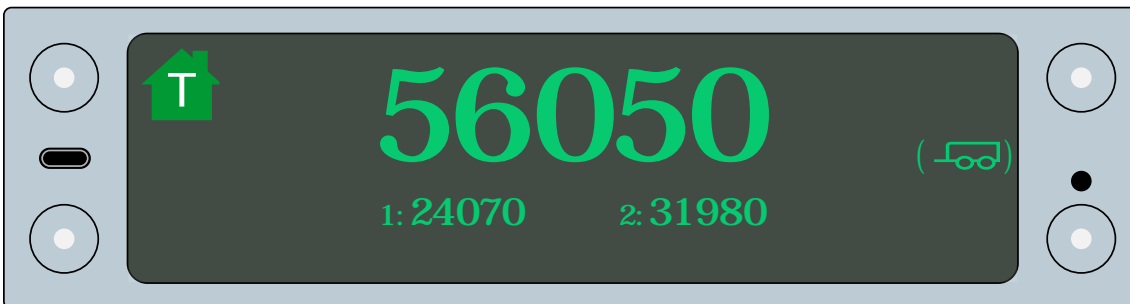

Axles are grouped into trailer groups for the purposes of measuring the weight applied to a trailer. See "Trailer / axle groups" on page 50.

Tap the toggle mode button to toggle between the display modes

## Menu password

A password is required to access different menus in the system.

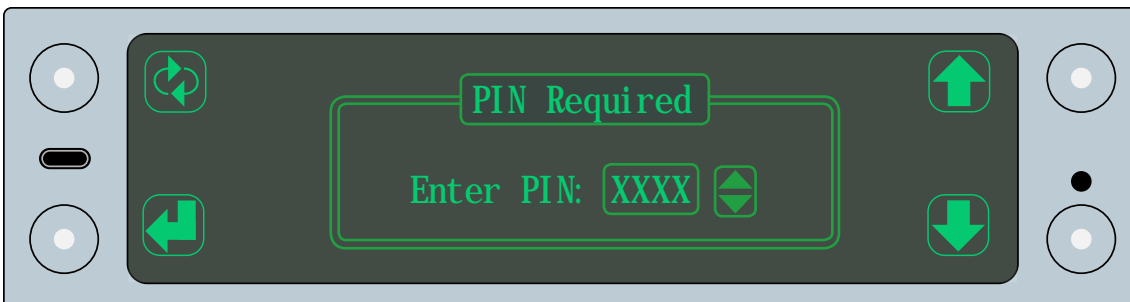

There are three passwords:

- Level 1 (User). This allows you to view the data on your system, but prevents access to the configuration menus.
- Level 2 (Manager). This allows you to view the data on your system and update the user settings, including the user password. This does not provide access to the configuration menus.
- Level 3 (Engineer). This allows you to view and access any menu and configuration settings.

---

Please contact your appropriate representative to obtain the password. The engineer password is required to configure the system.

---

## How to configure the weighing options

1. Tap the toggle mode button to open the gross display mode
2. Tap the cycle button until the configuration option is highlighted
3. Tap the select button to open the configuration menu

---

If multiple junction boxes are connected to the system, you are prompted to select a junction box.  
Select the junction box you want to apply any relevant changes to.

---

4. Tap the scroll up or scroll down buttons until the weighing config option is highlighted

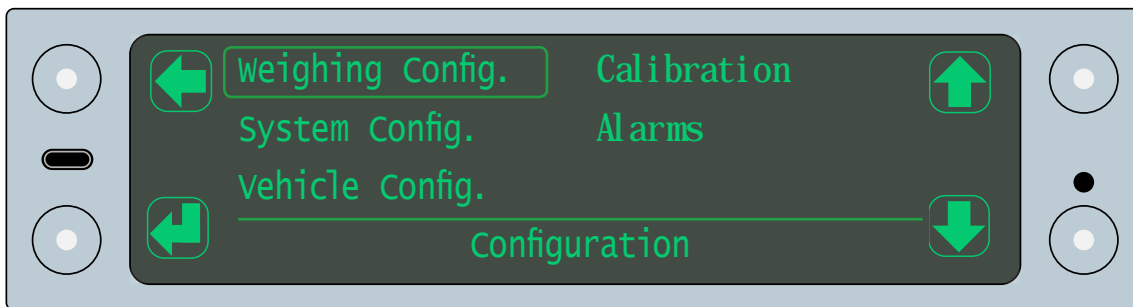

5. Tap the select button to open the weighing config menu

### Power on screen

The power on screen is displayed when you power on the display unit. By default, this is the axle display mode.

The power on screen can be set to show either the axle display mode or the gross display mode when the display unit is powered on.

1. Tap the scroll up or scroll down buttons until the power on screen option is highlighted

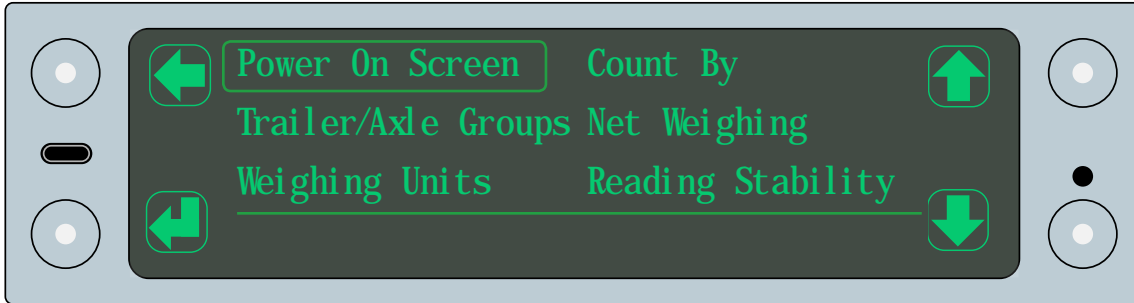

2. Tap the select button to open the power on screen setting

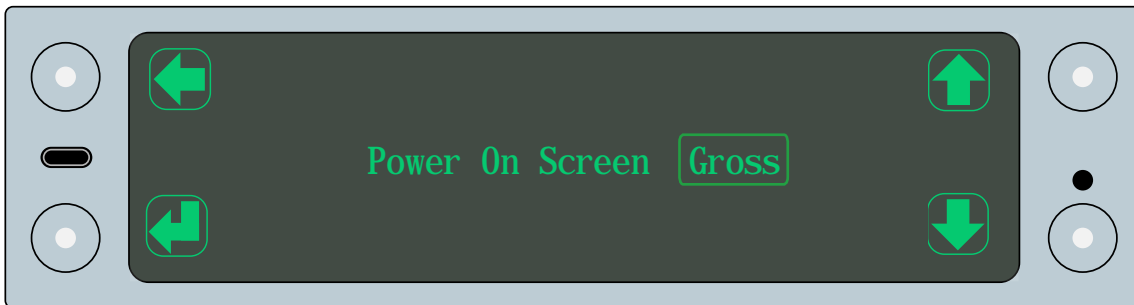

3. Tap the scroll up or scroll down button until the correct option is displayed
4. Tap the select button to select the power on screen option
5. Tap the go back button to save the setting and go back to the system weighing menu

## Trailer / axle groups

The trailer / axle groups settings allows you to group the axle measurements for display purposes on the axle display mode.

By creating a group, the weight measurements of all axles in a group are combined into a single value. This allows you to show the weight on air suspension systems, bogies or trailers

For example, if the second and third axles on a vehicle are fitted with a bogie, the weight measurements for these axles can be combined and displayed as a single value

1. Tap the scroll up or scroll down buttons until the trailer / axle groups option is highlighted

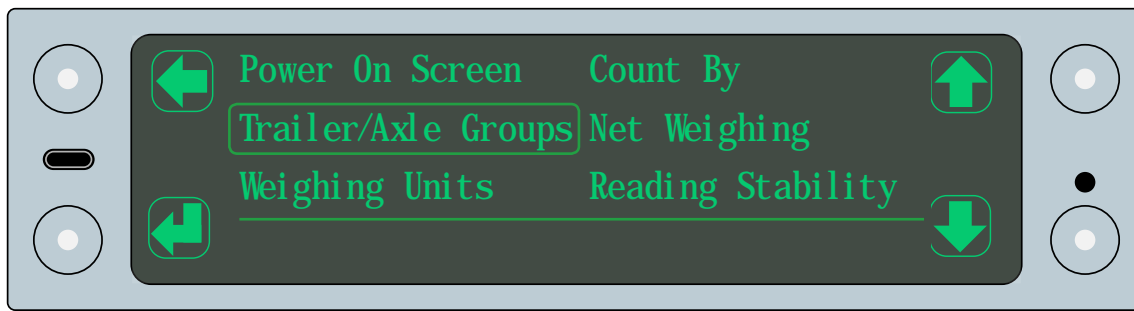

2. Tap the select button to open the trailer / axle groups setting

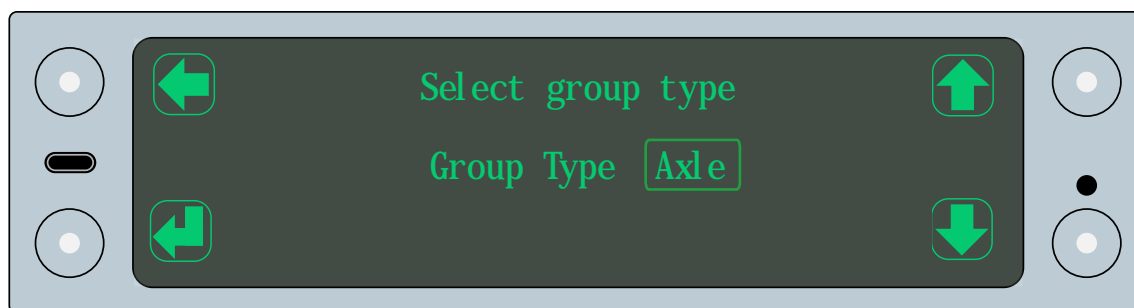

3. Tap the scroll up or scroll down button until the correct option is displayed
4. Tap the select button to select the group type

5. Tap the go back button to display the axle groups

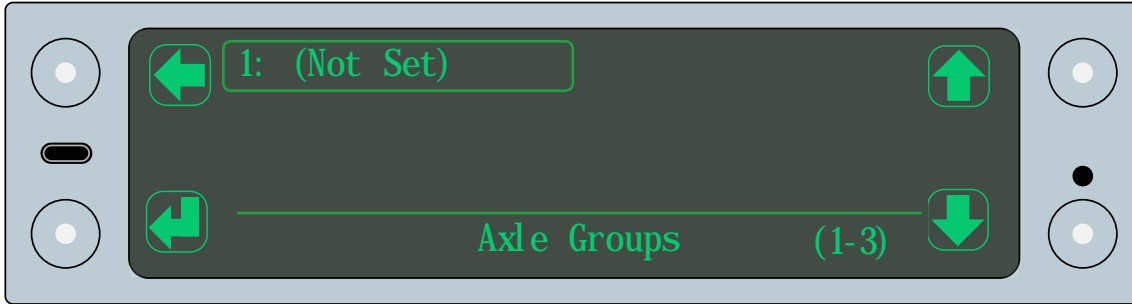

6. Tap the select button to open the first axle group
7. Input the axle range for the group:
  - Tap the scroll up or scroll down buttons to set the first axle
  - Tap the cycle button to highlight the second value
  - Tap the scroll up or scroll down buttons to set the last axle

---

Refer to your installation notes to determine which axles need to be grouped.

---

8. Tap the select button to save the group. If there are ungrouped axles on the vehicle, another line is added
9. Repeat steps 6 to 10 to create the groups for all axles on the vehicle

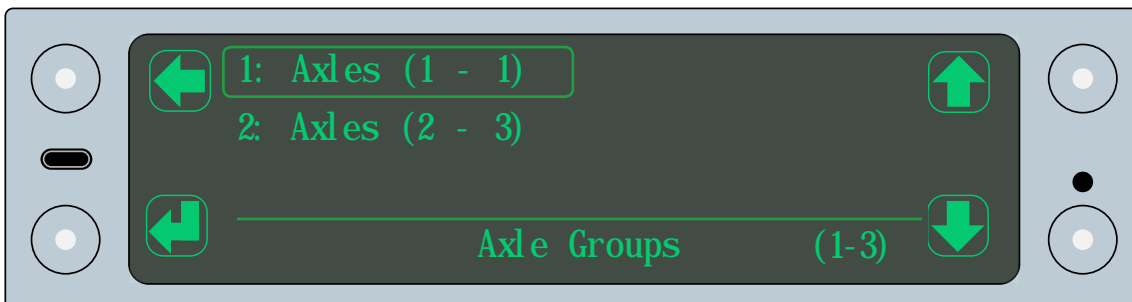

10. Tap the go back button
11. Tap the tick button to save the setting and go back to the system weighing menu



## Weighing units

It is extremely important to ensure this parameter is set correctly before the system is calibrated. For example; if the weighing units are set in kg (default) but the system is calibrated in lbs this will result in excessively large gain values which can cause system instability.

1. Tap the scroll up or scroll down buttons until the weighing units option is highlighted

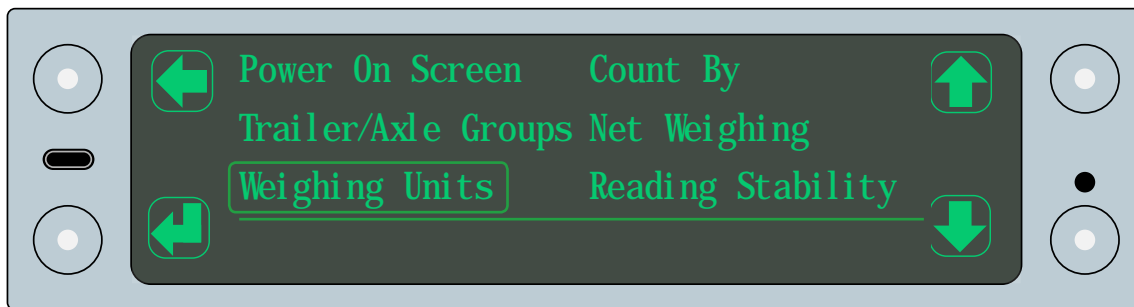

2. Tap the select button to open the weighing units setting

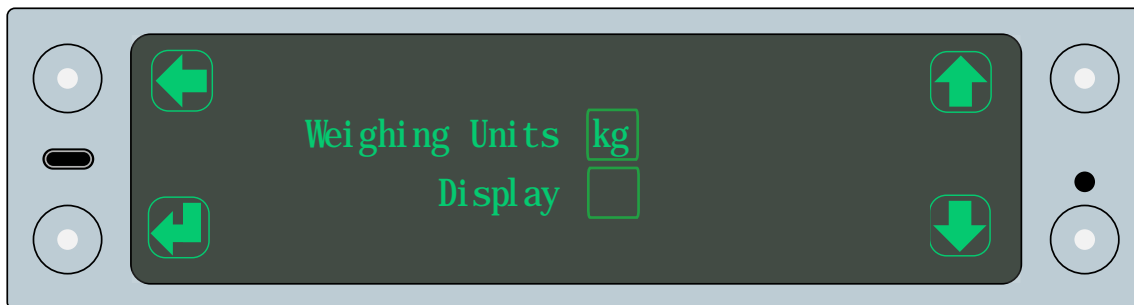

3. Tap the select button to access the weighing units setting
4. Tap the scroll up or scroll down buttons to select the appropriate unit to display weight measurements in
5. Tap the select button to save the unit
6. Tap the scroll up or scroll down buttons to highlight the display option
7. Tap the select button to tick or untick the setting. Tick to show the weighing units on the display
8. Tap the go back button to save the settings and go back to the system weighing menu

## Count by

1. Tap the scroll up or scroll down buttons until the count by option is highlighted

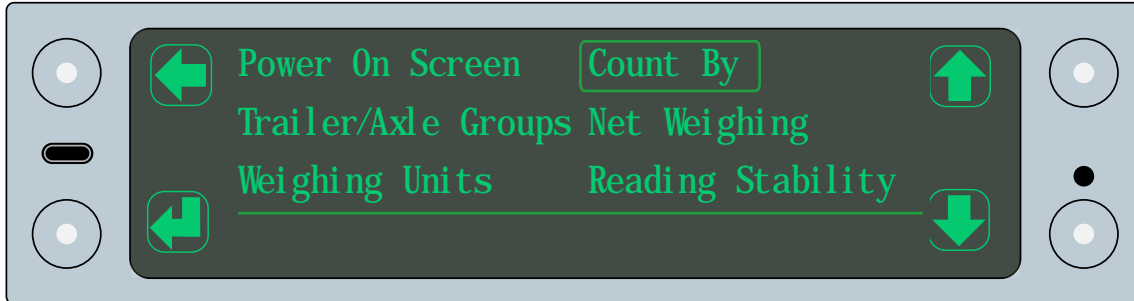

2. Tap the select button to open the count by setting

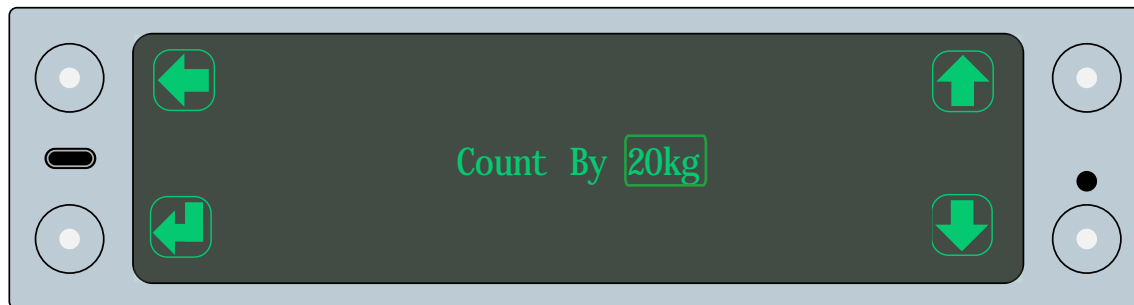

3. Tap the select button to access the setting
4. Tap the scroll up or scroll down buttons to select the value to round up the weight measurements to
5. Tap the select button to save the unit
6. Tap the go back button to save the setting and go back to the system weighing menu

## Net weighing

Net weighing allows you to change the display to show the net weight.

The net weight represents the weight of the load applied to the vehicle. This is the gross weight of the vehicle minus the weight of the vehicle with no load applied.

The weight of the vehicle with no load applied is called the zero weight. This is set during the calibration process. See "Calibration" on page 87

1. Tap the scroll up or scroll down buttons until the net weighing option is highlighted

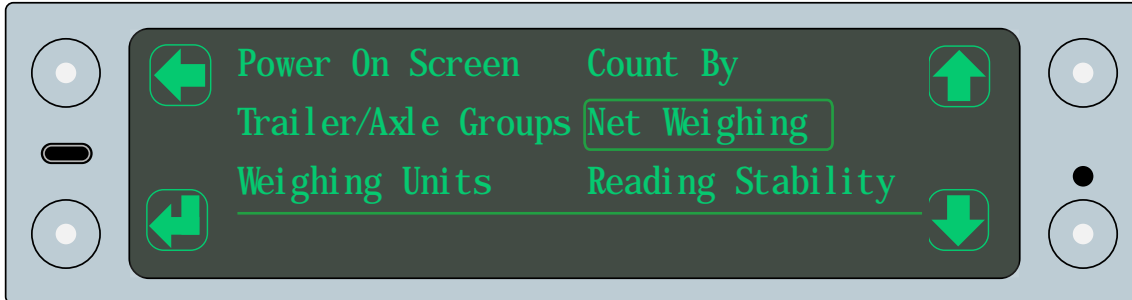

2. Tap the select button to open the net weighing setting

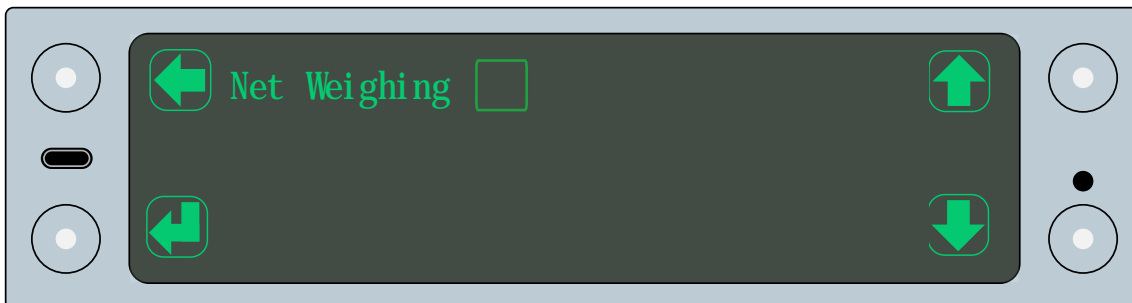

3. Tap the select button to access the setting
4. Tap the tick button to activate net weighing
5. Tap the go back button to save the setting
6. Tap the go back button to go back to the system weighing menu

## Reading stability

The weight measurement taken by the system can continually fluctuate as the vehicle moves. Reading stability is the acceptable level of change in the weight measurement.

If the weight measurement is not stable, an icon is displayed on the home screen:

---

Alarms will not trigger when the reading stability icon is displayed

---

1. Tap the scroll up or scroll down buttons until the stability option is highlighted

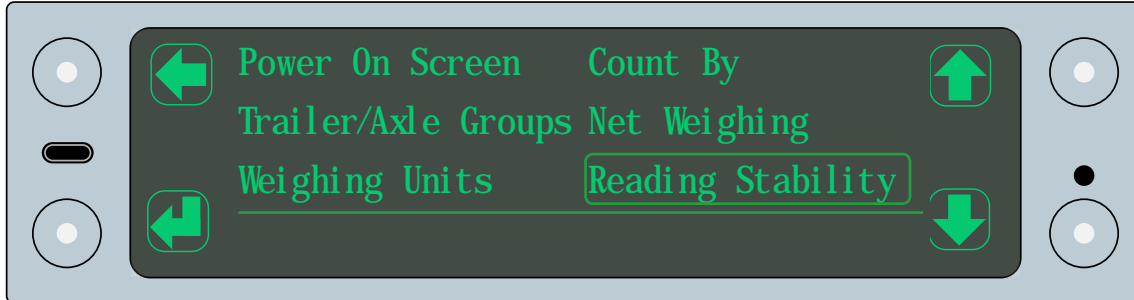

2. Tap the select button to open the stability menu

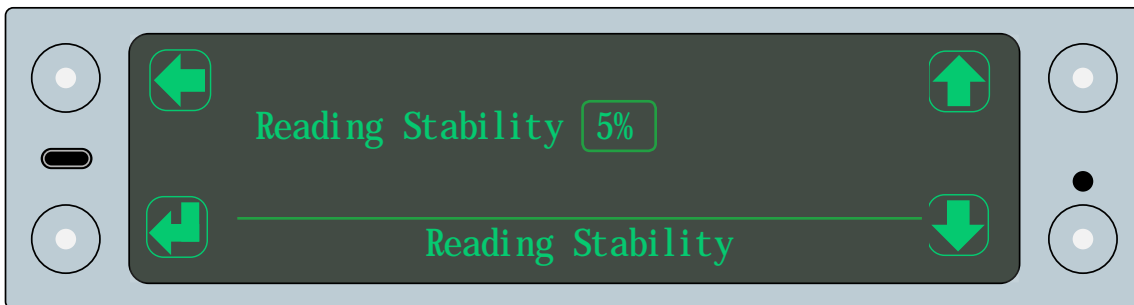

3. Tap the select button to activate the stability limit setting
4. Tap the scroll up or scroll down buttons to set the stability limit value
5. Tap the back button to return to the vehicle config menu

## How to configure the system

1. Tap the toggle mode button to open the gross display mode
2. Tap the cycle button until the configuration option is highlighted
3. Tap the select button to open the configuration menu

---

If multiple junction boxes are connected to the system, you are prompted to select a junction box.  
Select the junction box you want to apply any relevant changes to.

---

4. Tap the scroll up or scroll down buttons until the system config. option is highlighted

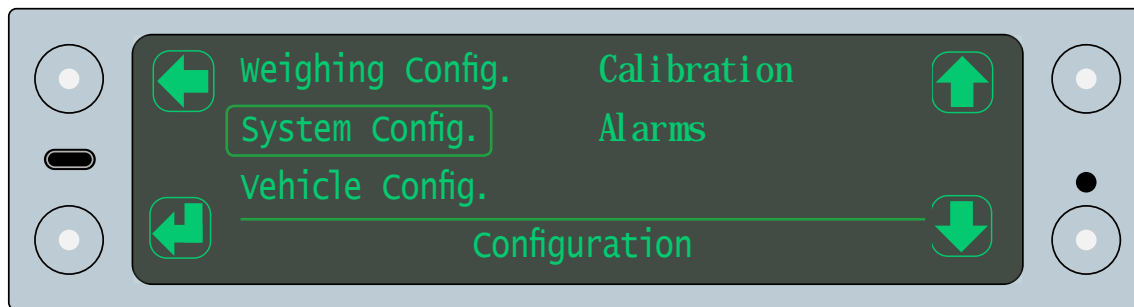

5. Tap the select button to open the system config menu

## RS232 serial outputs (activate external devices)

The RS232 serial output ports must be configured to enable the output for an external device such as a printer, alarm or telematic system.

Please ensure the external device has been plugged in to the appropriate port before it is activated

1. Tap the scroll up or scroll down buttons until the serial output option is highlighted

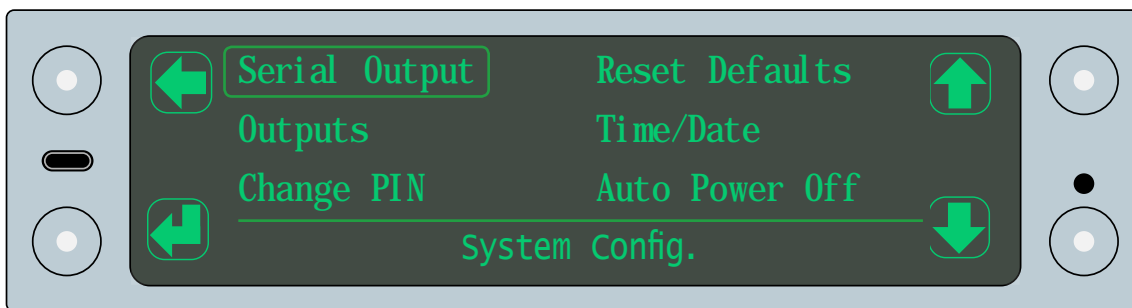

2. Tap the select button to open the serial output menu

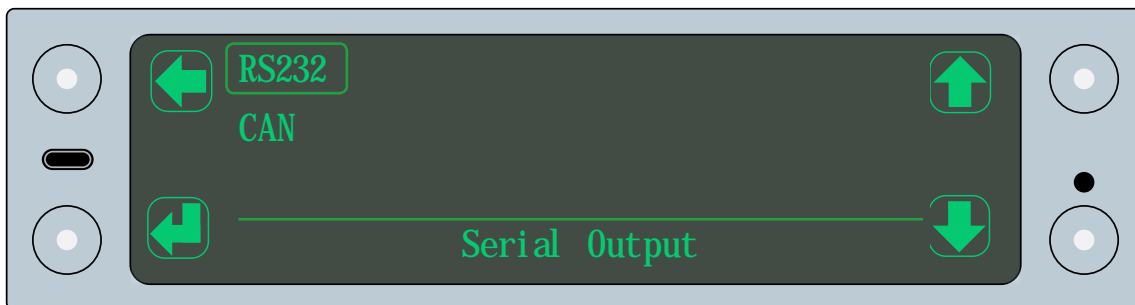

3. Tap the scroll up or scroll down buttons to select RS232

4. Tap the select button to open the RS232 menu

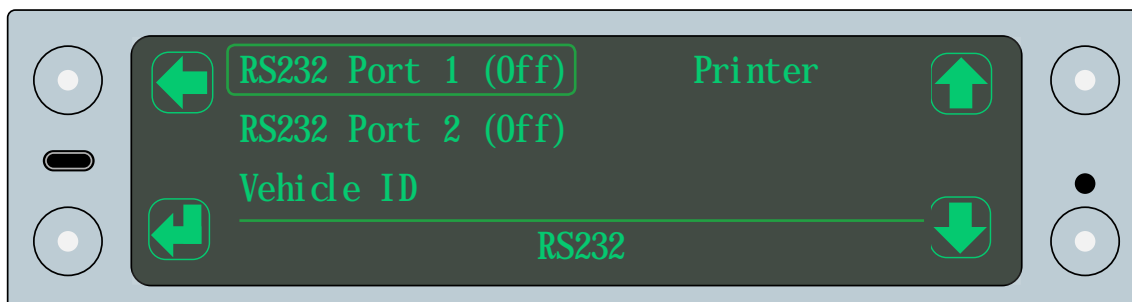

5. Use the scroll up or scroll down buttons to select an RS232 port.
  - Port 1 is the 9 way male D type connector. This is usually connected to a printer.
  - Port 2 is the 25 way female D type connector. This is usually used to transmit serial data to a 3rd party device.
6. Tap the select button to open the menu for the port

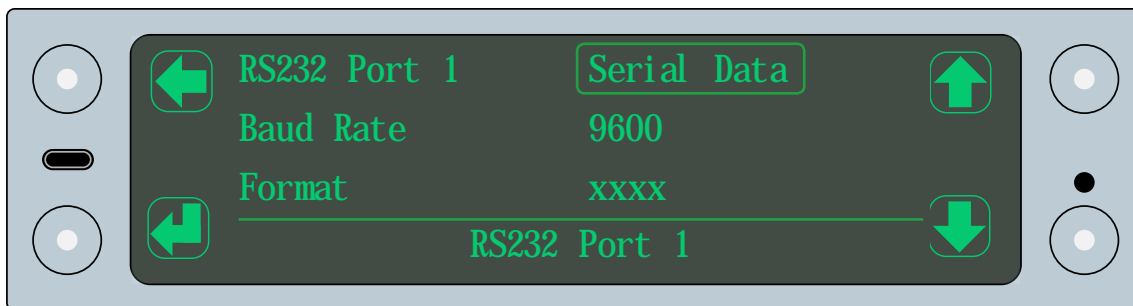

7. Use the scroll up or scroll down buttons to highlight a setting
8. Tap the select button to activate the setting
9. Use the scroll up or scroll down buttons to adjust the setting
10. Tap the select button to save the setting
11. Tap the go back button to go back to the RS232 menu

You can adjust the following settings:

- Port. Use this to activate the serial port. There are three options, each provides different settings:
  - Off
  - Serial Data. Select this to send serial data to an external device
    - Baud Rate. Use this to set the rate at which information is sent to the external device. This can be a maximum of 115200. Please refer to the manual for the external device to find the appropriate rate.
    - Format. It is recommended that this is left at the default setting. It allows you to change the output format to a version used in the previous TruckWeigh® system
    - Frequency. This determines the frequency of the transmission
    - Tx Retries. This determines the number of times the transmission is resent if the initial transmission fails
    - Ack Required. Tick this option to require a response from the external device to acknowledge the receipt of a transmission
- Printer. Select this to send information to a printer through the port. This will include the details set in the printer menu
  - Baud Rate. Use this to set the rate at which information is sent to the printer. This can be a maximum of 115200. Please refer to the manual for the external device to find the appropriate rate.
  - Handshake. Tick this option to require a handshake between the TruckWeigh® system and the printer to initiate the connection



## CAN serial output

The CAN serial output port must be configured to enable the output for an external device.

Please ensure the external device has been plugged in to the CAN port before it is activated

1. Tap the scroll up or scroll down buttons until the serial output option is highlighted

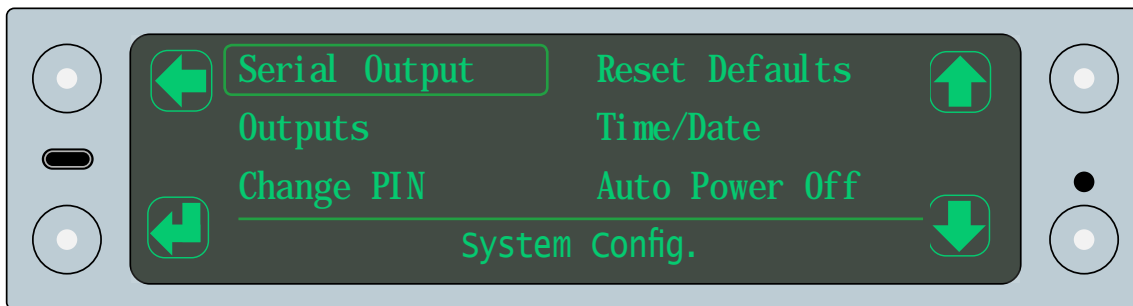

2. Tap the select button to open the serial output menu

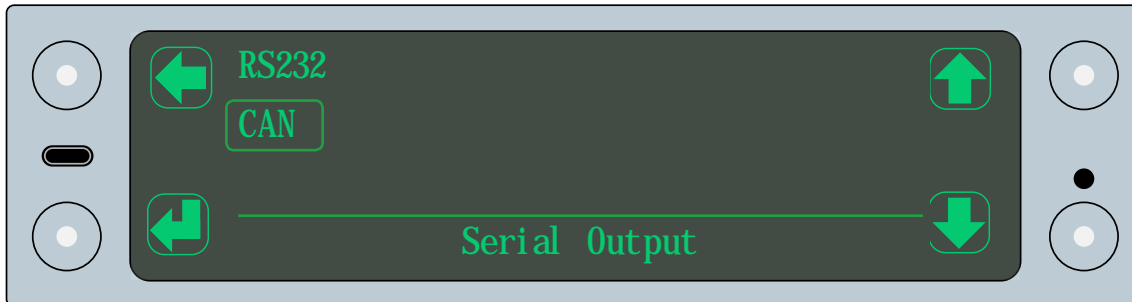

3. Tap the scroll up or scroll down buttons to highlight CAN

4. Tap the select button to open the CAN menu

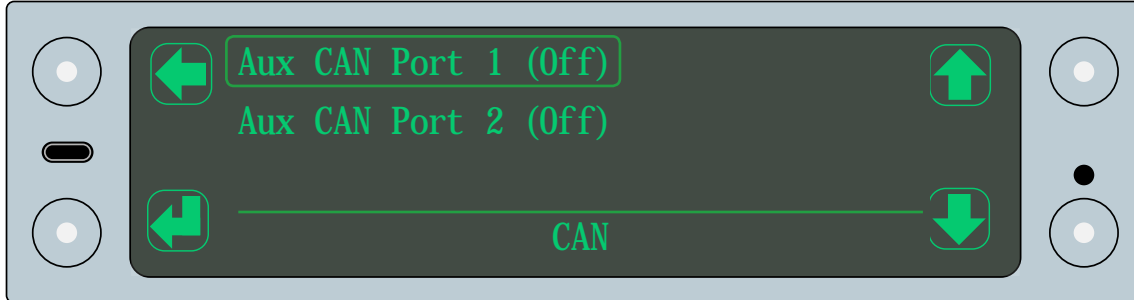

5. Use the scroll up or scroll down buttons to select a CAN port. Port 1 is the main port, port 2 is the auxiliary
6. Tap the select button to open the menu for the port



7. Use the scroll up or scroll down buttons to highlight a setting
8. Tap the select button to activate the setting
9. Use the scroll up or scroll down buttons to adjust the setting
10. Tap the select button to save the setting
11. Tap the go back button to go back to the serial output menu

You can adjust the following settings:

- Port. Use this to activate the CAN. There are two options:
  - Off
  - Weights. Select this to send weight data to an external device
    - Baud Rate. Use this to set the rate at which information is sent to the external device. This can be a maximum of 115200. Please refer to the manual for the external device to find the appropriate rate.

## Vehicle ID

The vehicle ID is used when sending data via a serial port. The ID can be set to the requirements of your organisation. For example, it can be a number plate or fleet number etc.

1. Tap the scroll up or scroll down buttons until the serial output option is highlighted

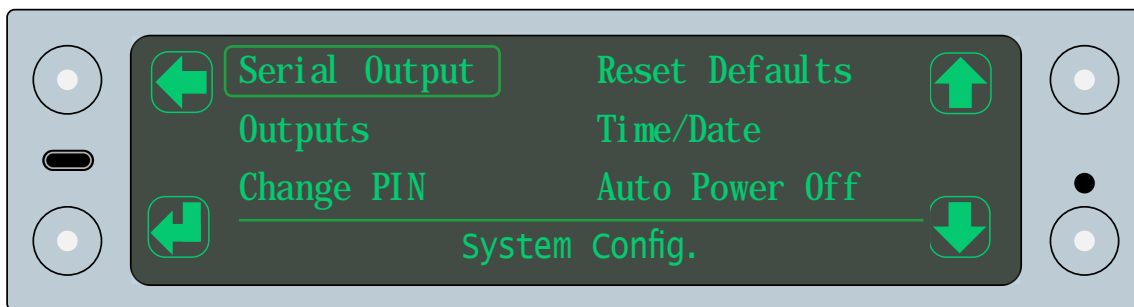

2. Tap the select button to open the serial output menu

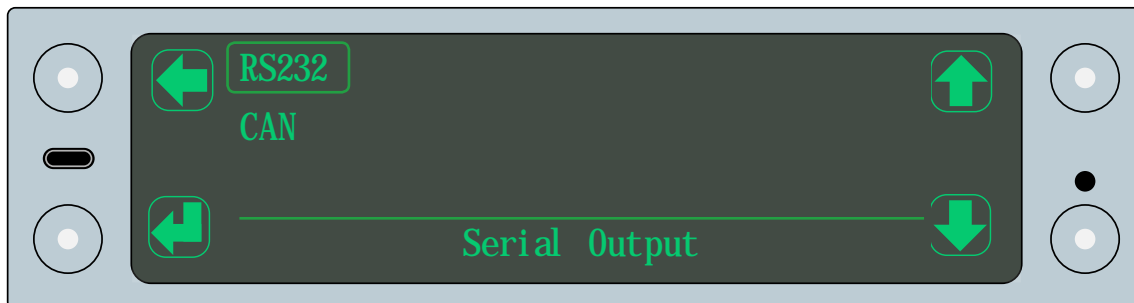

3. Tap the scroll up or scroll down buttons to select RS232

4. Tap the select button to open the RS232 menu

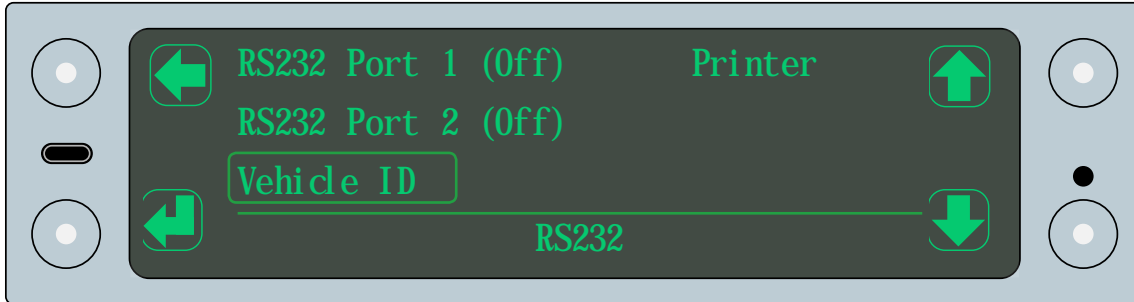

5. Tap the scroll up or scroll down buttons to highlight the vehicle ID option
6. Tap the select button to open the vehicle ID menu

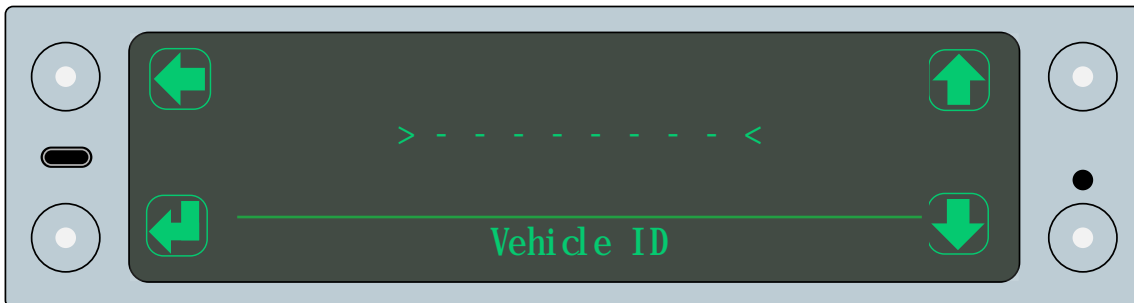

7. Tap select to activate the vehicle ID setting
8. Use the cycle and scroll buttons to change each character of the vehicle ID
9. Tap the select button to save the change
10. Tap the back button to return to the RS232 menu

## Printer

Use the printer menu to define the settings for the printed output

1. Tap the scroll up or scroll down buttons until the serial output option is highlighted

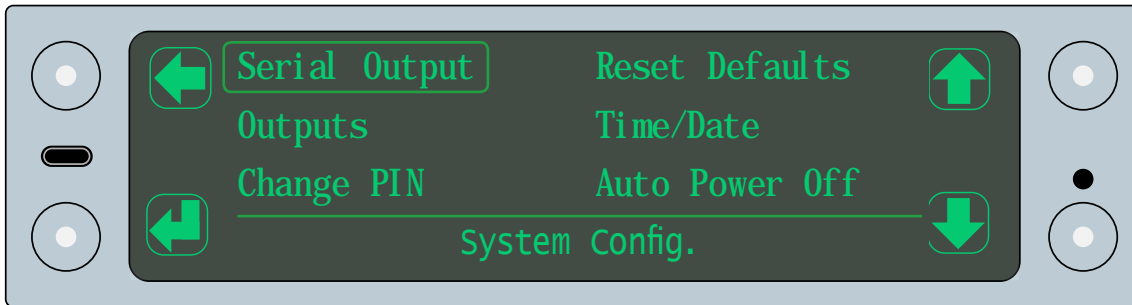

2. Tap the select button to open the serial output menu

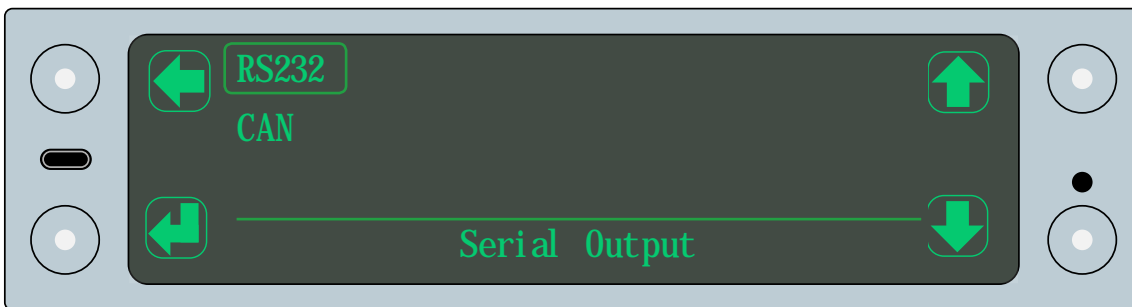

3. Tap the scroll up or scroll down buttons to select RS232

4. Tap the select button to open the RS232 menu

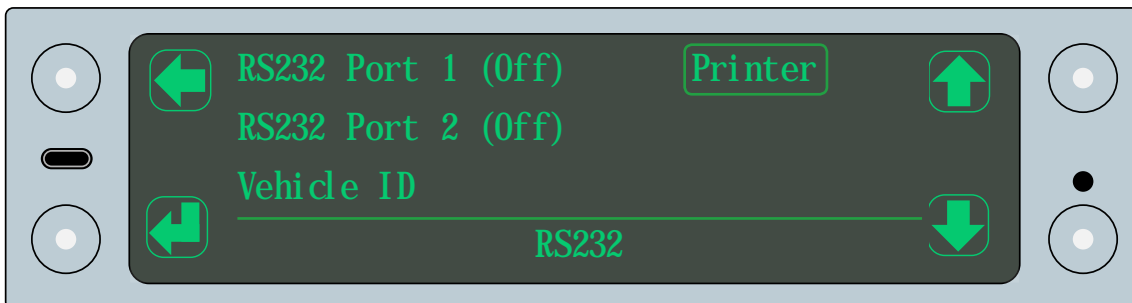

5. Tap the scroll up or scroll down buttons to highlight the printer option

6. Tap the select button to open the printer menu

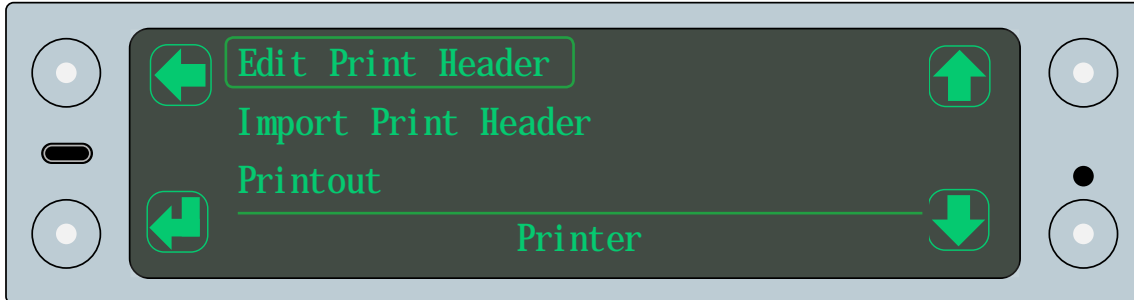

7. Use the edit print header menu to manually edit the print header which is used on a printout
8. Plug in a USB device and use the import print header to import a text file to define the print header used on a printout
9. Use the printout menu to define what information is printed on a printout. You can select the following options
  - Language
  - Print header
  - Vehicle ID
  - Net
  - Gross
  - Axles
  - Trailer / Axle Groups

## Output settings for external devices

Output settings are related to the type of external device connected to the 25 PIN port, such as an alarm or warning light. It allows you to define how and when a signal is sent to the device.

1. Tap the scroll up or scroll down buttons until the outputs option is highlighted

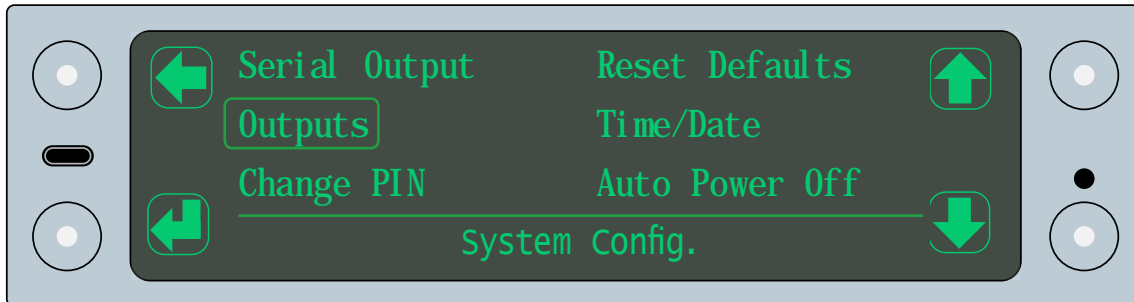

2. Tap the select button to open the outputs menu

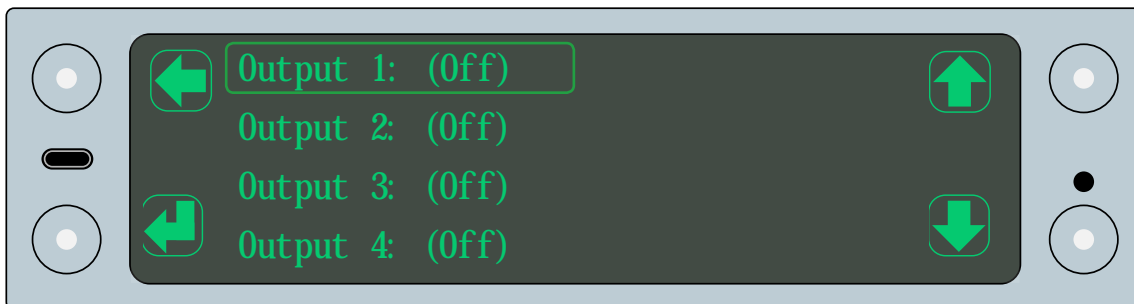

3. Tap the scroll up or scroll down buttons to select an output
4. Tap the select button to access the output setting

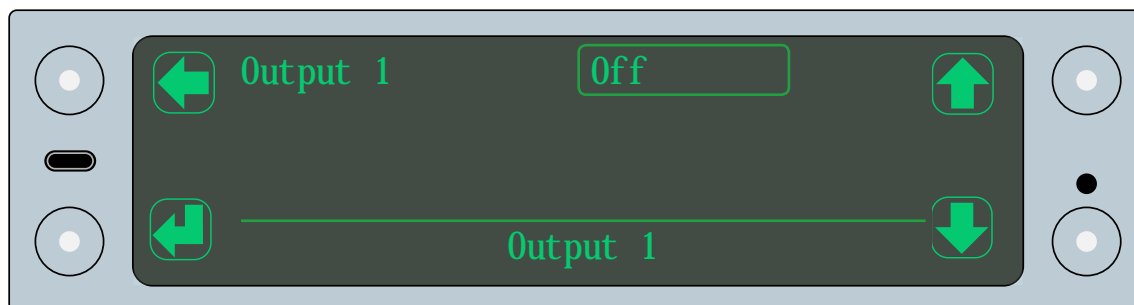

5. Tap the select button to activate the setting

6. Tap the scroll up or scroll down buttons to select the appropriate type of signal to send to the external device. There are four options:
  - Pulse low. The output is high until triggered. Once triggered the level is low for the duration set in the associated parameter before returning to a high state.
  - Pulse high. The output is low until triggered. Once triggered the level is high for the duration set in the associated parameter before returning to a low state.
  - Active low. This is a constant high signal that drops to a constant low signal when it is triggered
  - Active high. This is a constant low signal that rises to a constant high signal when it is triggered
7. Tap the select button to save the output signal. This will display additional fields. The fields vary depending on the type of trigger
8. Tap the scroll down button to highlight the trigger option
9. Tap the select button to access the trigger option.



10. Tap the scroll up or scroll down buttons to select the trigger. The trigger setting is used to determine what action activates the output signal. There are several options:

- Gross Weight. Select this to send a signal when the vehicle reaches a specific gross weight
- Input. Select this to send a signal when the system receives another signal from an external device
- Body Up. Select this to send a signal when the vehicle body is raised
- Load Stability. Select this to send a signal when the load stability decreases below a specific value
- Vehicle Stability. Select this to send a signal when the vehicle stability decreases below a specific value
- Set Point Alarm. Select this to send a signal when a set point alarm is triggered
- Trailer Weight. Select this to send a signal when the weight of a trailer reaches a specific weight
- Axle Weight. Select this to send a signal when the weight on an axle reaches a specific weight
- Axle Group. Select this to send a signal when the weight on an axle group reaches a specific weight
- Net Weight. Select this to send a signal when the vehicle reaches a specific net weight

---

Each signal type and trigger option has additional parameters that are used to configure the type of trigger. For example; a pulse signal will require a pulse time value to determine the length of each pulse A weight trigger will require an on and off weight value and a filter time to delay the signal in case a value is reached accidentally. A set point alarm trigger will need to be linked to the set point alarm you want to use etc.

---

11. Use the scroll and select buttons to set the additional parameters for the output.

## Change PIN

There are three PIN numbers which allow different levels of access to the system. See “Menu password” on page 46 for further information.

Each level of access is able to reset its own PIN number.

1. Tap the scroll up or scroll down buttons until the Change PIN option is highlighted

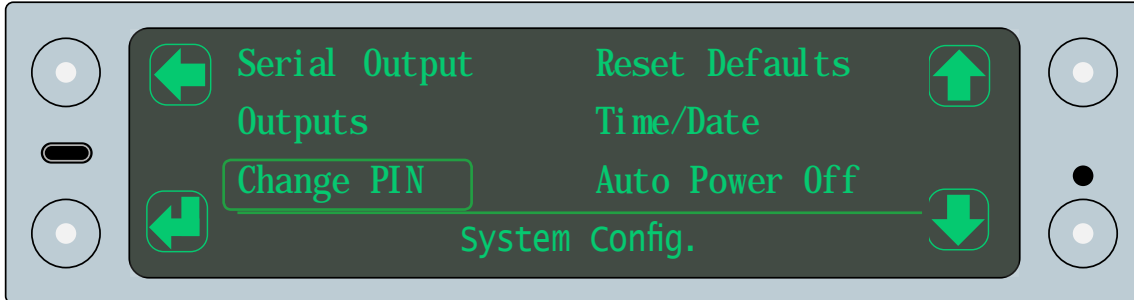

2. Tap the select button to open the change PIN menu

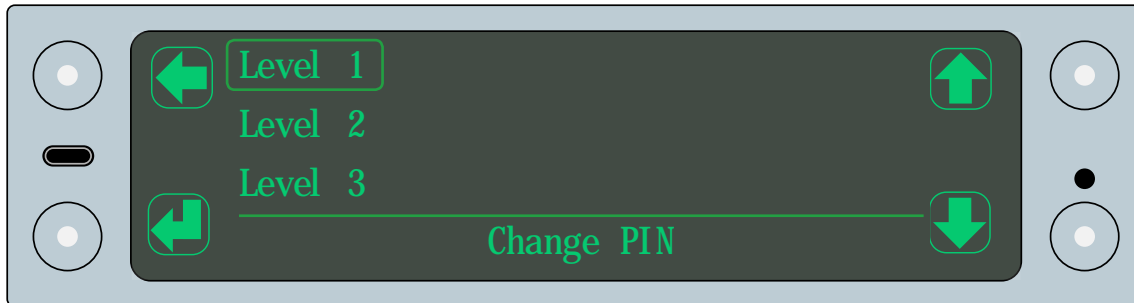

3. Tap the scroll up or scroll down buttons to highlight a PIN

4. Tap the select button to select the PIN

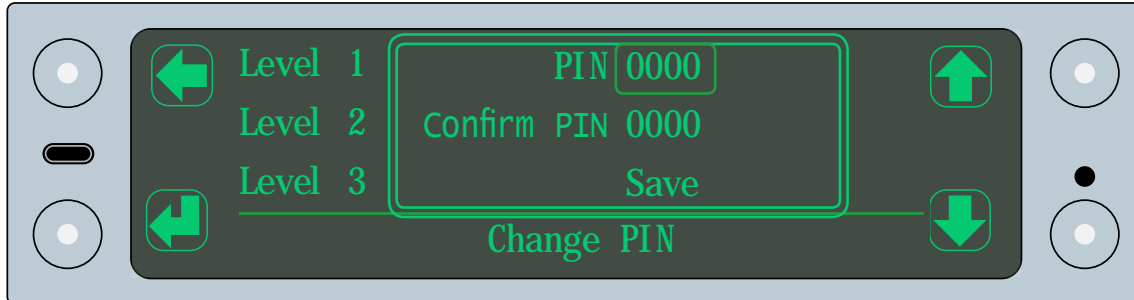

5. Use the scroll and select buttons to change the PIN and save it
6. Tap the go back button go back to the system configuration menu

## Reset defaults

1. Tap the scroll up or scroll down buttons until the reset defaults option is highlighted

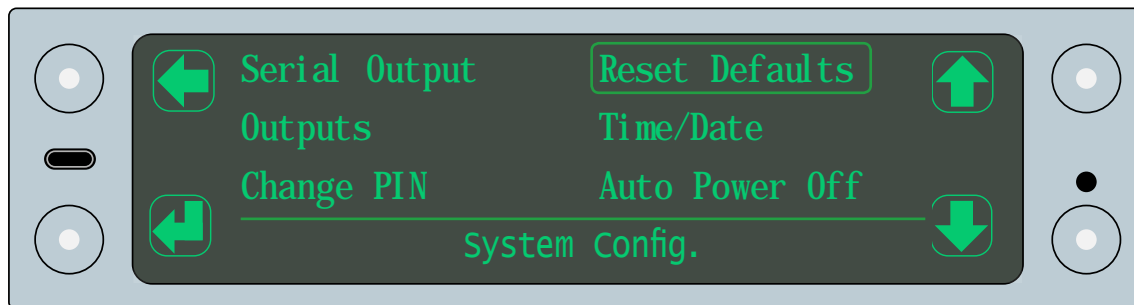

2. Tap the select button to open the reset defaults menu

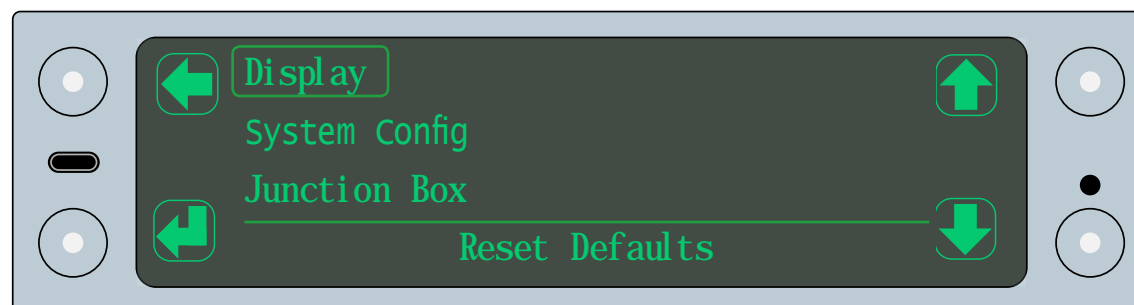

3. Tap the scroll up or scroll down buttons to highlight an option. There are three options:
  - Display. This will reset the settings for the display to the default values
  - System Config. This will reset the settings in the system configuration to their default values
  - Junction Box. This will reset the vehicle and calibration settings for the junction box to the default values
4. Tap the select button to reset to default values
5. Tap the tick button to confirm
6. Tap the go back button go back to the system configuration menu

## Time/date

1. Tap the scroll up or scroll down buttons until the set time/date option is highlighted

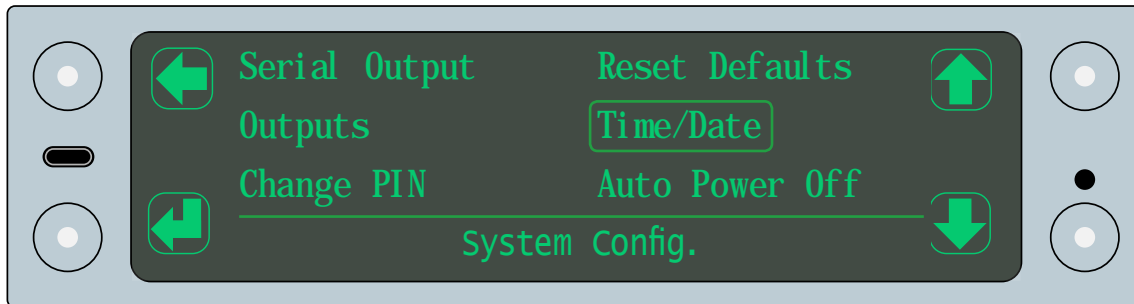

2. Tap the select button to open the set time/date menu

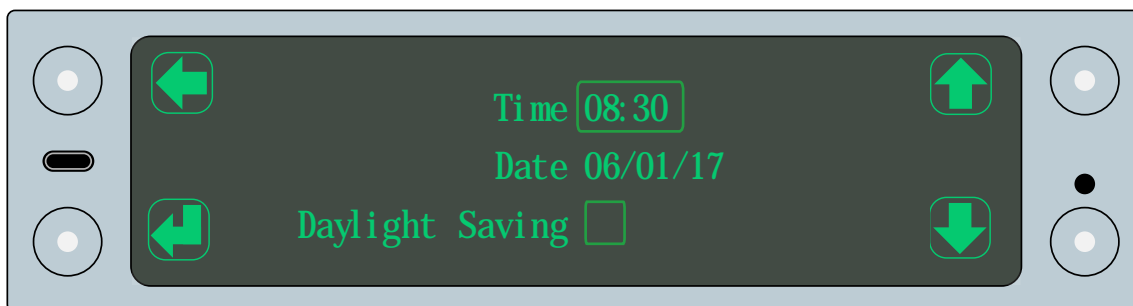

3. Use the scroll and select buttons to set the current time, date and enable or disable the daylight saving setting
4. Tap the go back button to save the setting and go back to the system configuration menu

## Auto power off

When the system is configured to switch on when the ignition is turned on, the auto power off feature is used to determine how long the system will remain on after the ignition is turned off.

1. Tap the scroll up or scroll down buttons until the auto power off option is highlighted

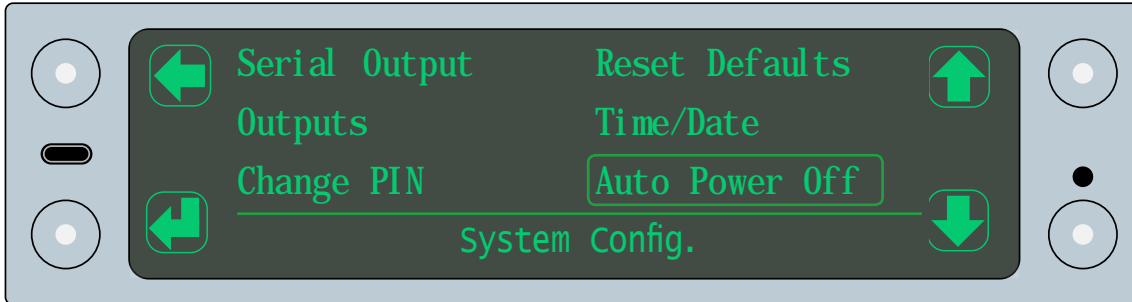

2. Tap the select button to open the auto power off menu

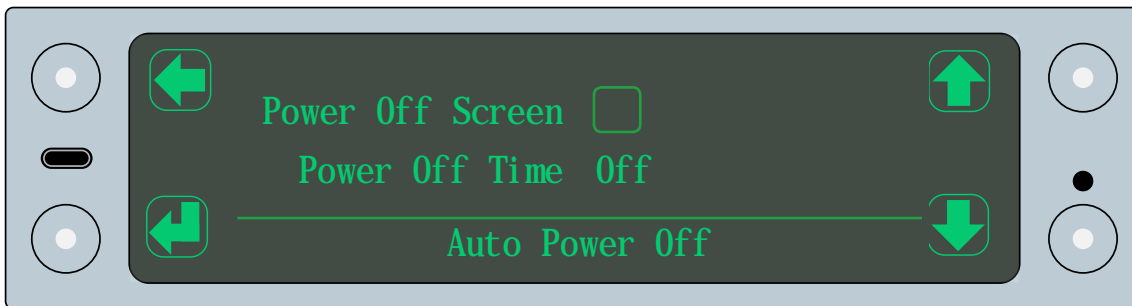

3. Use the scroll and select buttons to activate the power off screen and set the number of minutes it will wait before activating
4. Tap the go back button to save the setting and go back to the system configuration menu

## How to input the vehicle configuration

Junction boxes must be configured to reflect the sensors they are connected to. The junction boxes are configured using the display unit installed in the cab.

If there are multiple junction boxes, each must be configured in turn. For example; A truck and a trailer will contain multiple junction boxes, one for the truck, one for the trailer.

1. Tap the toggle mode button to open the gross display mode
2. Tap the cycle button until the configuration option is highlighted
3. Tap the select button to open the configuration menu
4. Tap the scroll up or scroll down buttons until the vehicle config option is highlighted

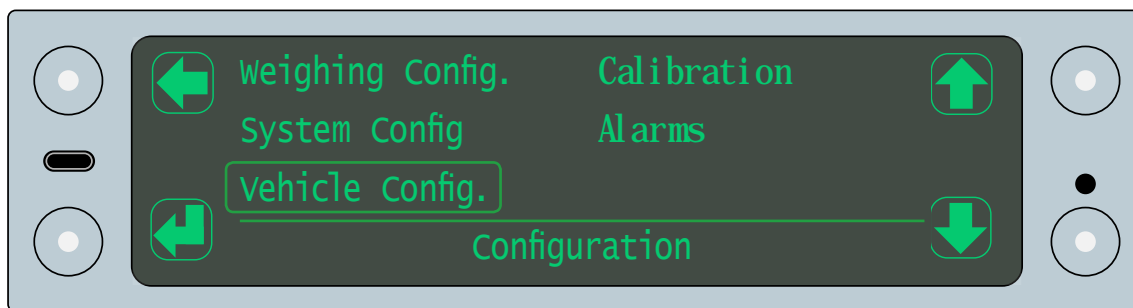

5. Tap the select button to open the vehicle configuration menu

---

If multiple junction boxes are connected to the system, you are prompted to select a junction box.  
Select the junction box you want to apply any relevant changes to.

---

## Junction box orientation

1. Tap the scroll up or scroll down buttons until the jbox orientation option is highlighted

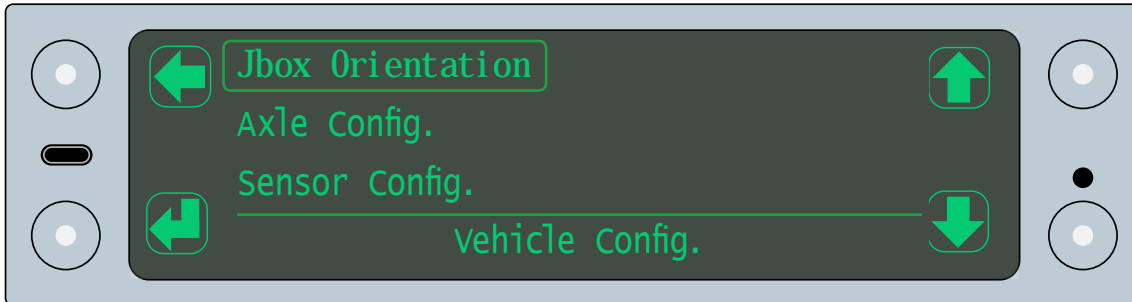

2. Tap the select button to open the junction box orientation menu
3. Tap the select button to activate the jbox orientation setting

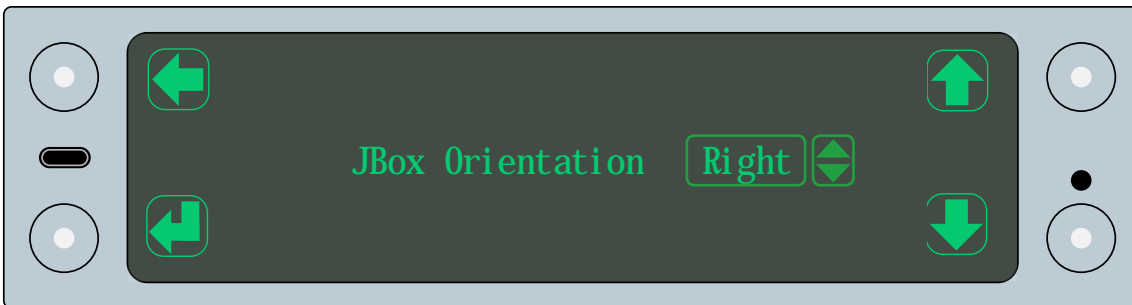

4. Tap the scroll up or scroll down button until the correct orientation option is displayed
5. Tap the select button to select the orientation option

---

The junction box orientation is determined by the direction the top face of the box is facing. For example; Up, down, left side or right side of the vehicle. Please see "How to install the junction box" on page 22 for further details.

---

6. Tap the go back button to save the setting and go back to the vehicle configuration menu



## Axle configuration

1. Tap the scroll up or scroll down buttons until the axle config option is highlighted

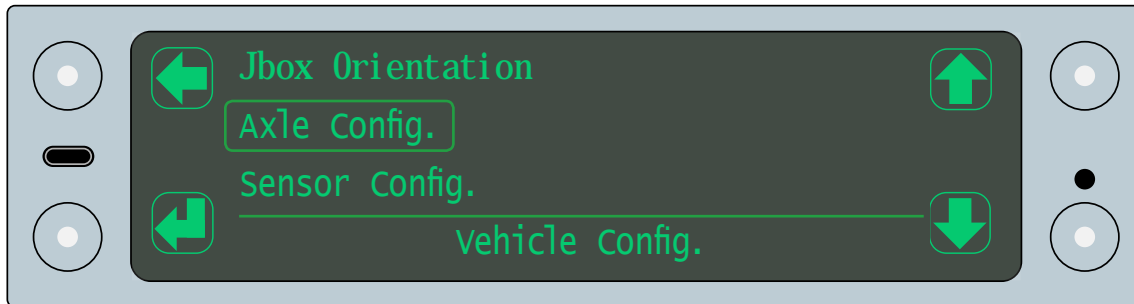

2. Tap the select button

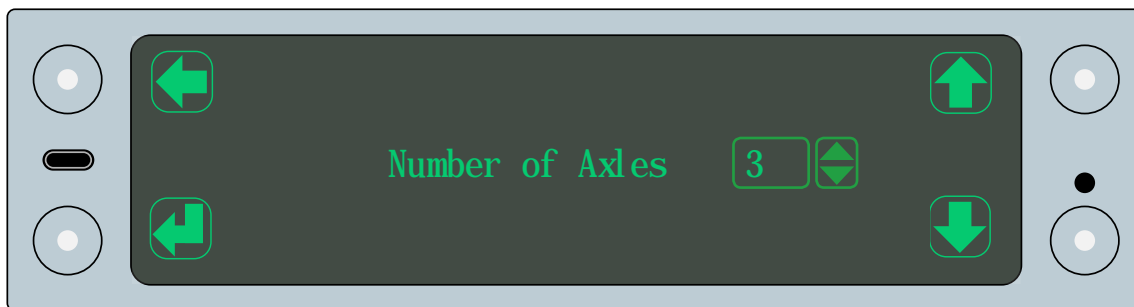

3. Tap the select button to access the number of axles option
4. Use the scroll up or scroll down buttons to input the number of axles on the chassis that the junction box is attached to
5. Tap the select button to set the number of axles
6. Tap the back button to open the axle config menu

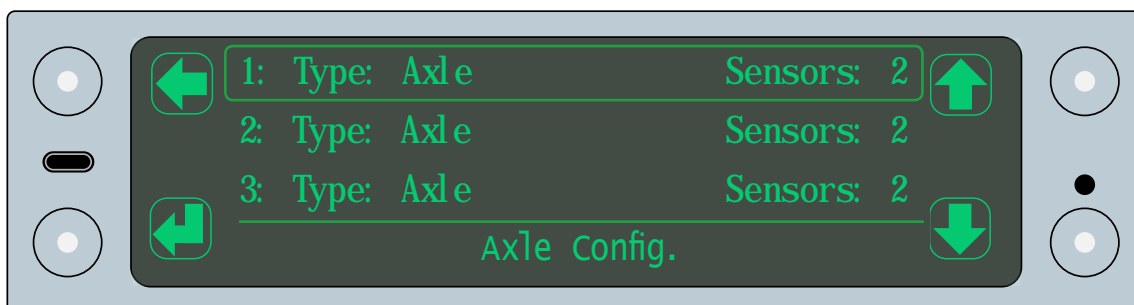

This menu shows the axle configuration for your vehicle. Each line represents an individual axle and shows the type of sensor and the number of sensors installed on the axle.

7. Tap the scroll up or scroll down buttons to highlight an axle
8. Tap the select button to open the settings for the axle
9. Select the appropriate axle type and number of sensors attached to it. There are four axle configurations:
  - Axle. This is used to indicate that axle transducers are located on a single leaf spring axle. This type of configuration will usually have 2 sensors on each axle, one for each side of the vehicle.

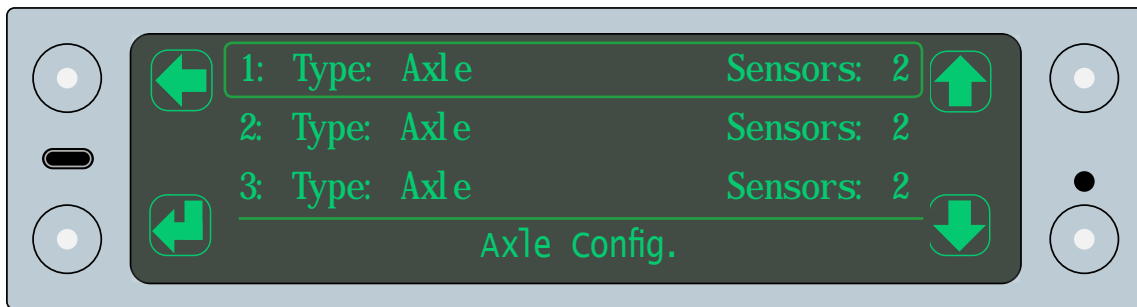

- Tag. This is used to indicate that axle transducers are located on a single tag axle which is only deployed over a specific weight. This may be an air group or use axle transducers.

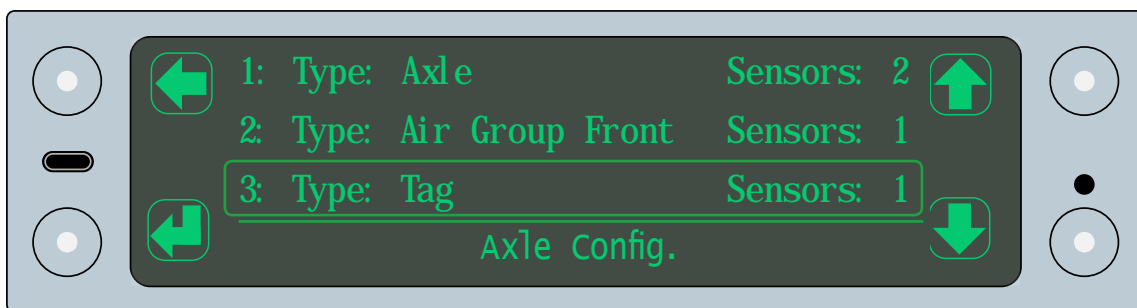

- Air group. This is used to indicate that air transducers are located on the axle. All axles which use the same air pressure transducers must be configured as part of the same group. There are three options:
  - Air group front. This is used to indicate the first axle in an air group. If a single air sensor is used for the whole group, the number of sensors is 1. If a single sensor is used to measure the left side of the group and a single sensor used to measure the right side, the number of sensors is 2.
  - Air group centre. This is used to indicate any axle between the front and rear axle of the air group. The number of sensors is always the same as the number of sensors on the Air group front axle.
  - Air group rear. This is used to indicate the last axle in the air group. The number of sensors is always the same as the number of sensors on the axle at the front of the air group.

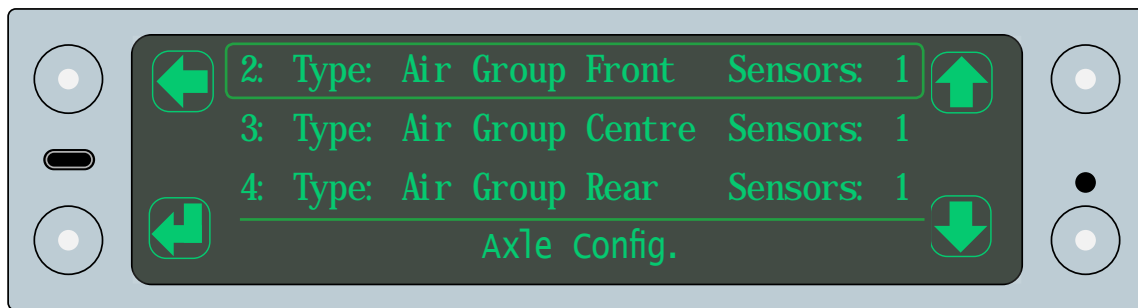

Multiple air groups should not be combined into one group. For example, if an air group is located on axle 2 and 3, and a second air group is located on axle 4, 5 and 6. In this case, axle 2 is an air group front and axle 3 is an air group rear. Axle 4 is an air group front, axle 5 is an air group middle and axle 6 is an air group rear.

- Bogie. This is used to indicate that axle transducers are located on a bogie. All axles which the bogie is fitted to must be configured as part of the same group. There are four options:
  - Bogie front. This is used to indicate the first axle fitted to the bogie. This is used if the bogie is configured to spread the weight evenly across the axles. The number of sensors is the total number of sensors for the front axle of the bogie.
  - Bogie rear. This is used to indicate the last axle fitted to the bogie. This is used if the bogie is configured to spread the weight evenly across the axles. The number of sensors is the total number of sensors for the rear axle of the bogie.
  - ASym bogie front. This is used to indicate the first axle fitted to the bogie. This is used if there is an uneven load distribution on the bogie axles. The number of sensors is the total number of sensors for the front axle of the bogie.
  - ASym bogie rear. This is used to indicate the last axle fitted to the bogie. This is used if there is an uneven load distribution on the bogie axles. The number of sensors is the total number of sensors for the rear axle of the bogie.

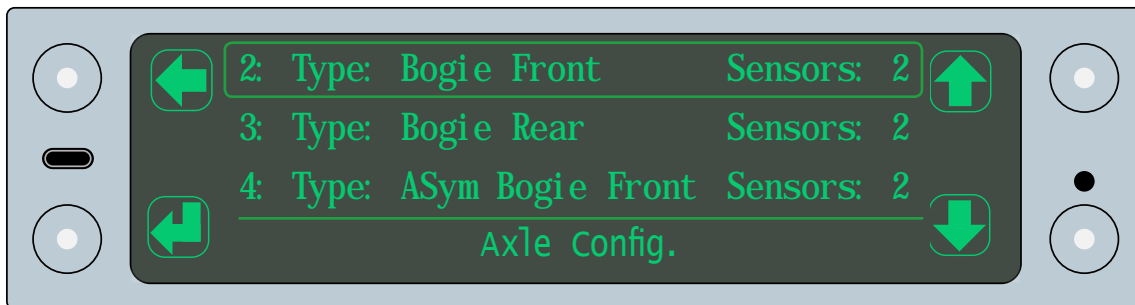

10. Tap the back button to exit the axle configuration menu return to the vehicle config menu
11. Tap the yes button to save any changes

## Sensor configuration

1. Tap the scroll up or scroll down buttons until the sensor config option is highlighted

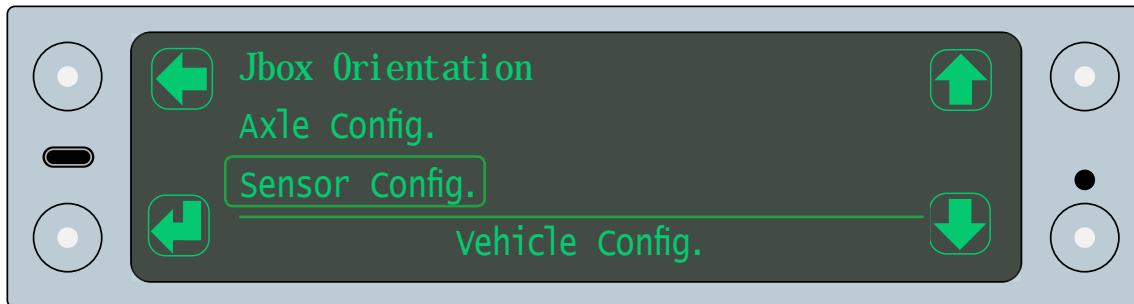

2. Tap the select button to open the sensor configuration menu

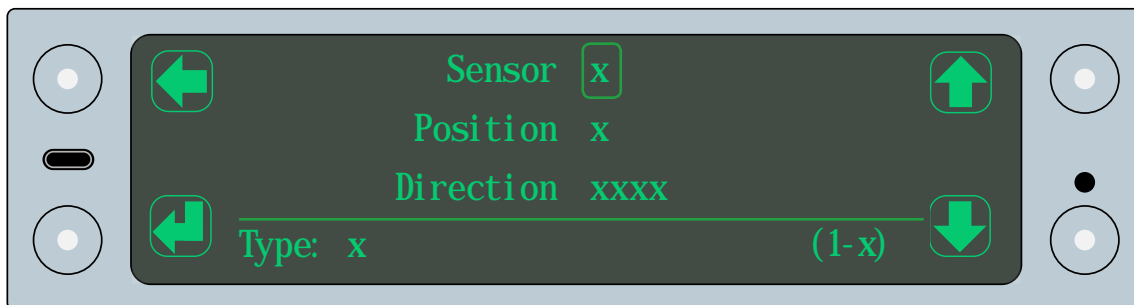

The sensor serial number is displayed in the sensor field.

3. Select a sensor:

- Use the scroll up and down buttons to highlight the sensor field and tap the select button to open it.
- Use the scroll up and down buttons to scroll through the sensors and tap the back button to return

The sensor type and sensor range for the junction box are displayed at the bottom of the screen.

4. Select the position for the sensor:

- Use the scroll up and down buttons to highlight the position field and tap the select button to open it.
- Use the scroll up and down buttons to select a position number and tap the back button to return

The position number is the position of the sensor on the vehicle. Number 1 is the sensor on the front axle, this is the sensor on the left side of the axle if it is not an air group, 2 is the sensor on the right. 3 is the sensor on the left side of the second axle etc. See "Sensor installation positions" on page 26 for more information.

5. Select the direction for each axle sensor:

- Use the scroll up and down buttons to highlight the direction field and tap the select button to open it.
- Use the scroll up and down buttons to select a direction, e.g. facing forward, facing backward
- Tap the back button to return

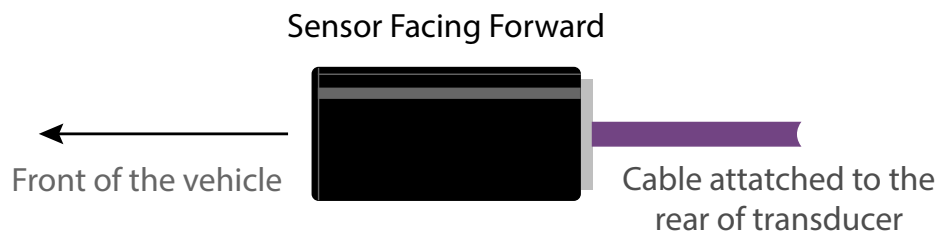

6. Repeat steps 3 to 5 to ensure each sensor is configured correctly. For example:

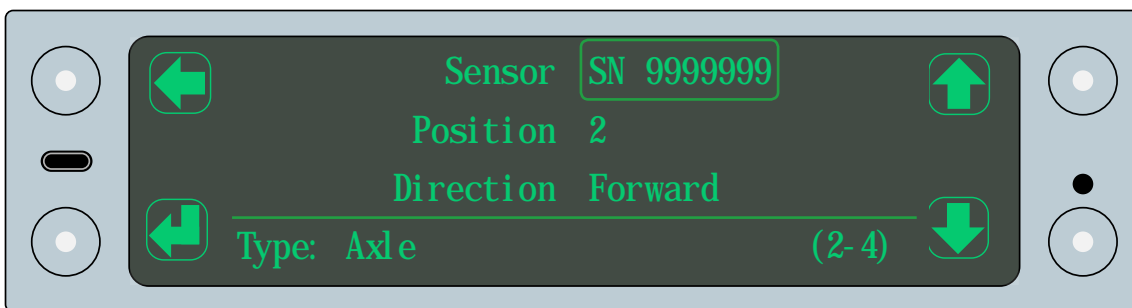

In the example above, the sensor with serial number 99999999 is installed on the right hand side of the first axle, with the front face of the sensor pointing toward the front of the vehicle.

7. Tap the back button to exit the sensor configuration menu return to the vehicle config menu
8. Tap the yes button to save the sensor configuration

## How to configure alarms

Alarms can be set to trigger at different weight measurements. There are several types of alarms available in the system:

- Automatic alarms. These alarms are active by default and cannot be deactivated:
  - Gross train weight. This represents the maximum gross weight permitted for the whole vehicle. This is determined by the values defined for the gross alarms on each junction box
- Defined alarms. These alarms can be activated or deactivated as required. They are configured for each junction box. Each alarm is related to the chassis of the vehicle where the junction box is installed:
  - Gross. This represents the maximum gross weight permitted for the chassis
  - Net. This represents the maximum load weight which can be placed on the chassis
  - Axle. This represents the maximum load which can be applied to an axle on the chassis
  - Set Point. These are user configurable alarms based on the gross weight on the chassis
  - Axle Underload. This represents the minimum percentage of the current gross weight of the vehicle that must be distributed to the front axles on the chassis

1. Tap the toggle mode button to open the gross display mode
2. Tap the cycle button until the configuration option is highlighted
3. Tap the select button to open the configuration menu
4. Tap the scroll up or scroll down buttons until the alarms option is highlighted

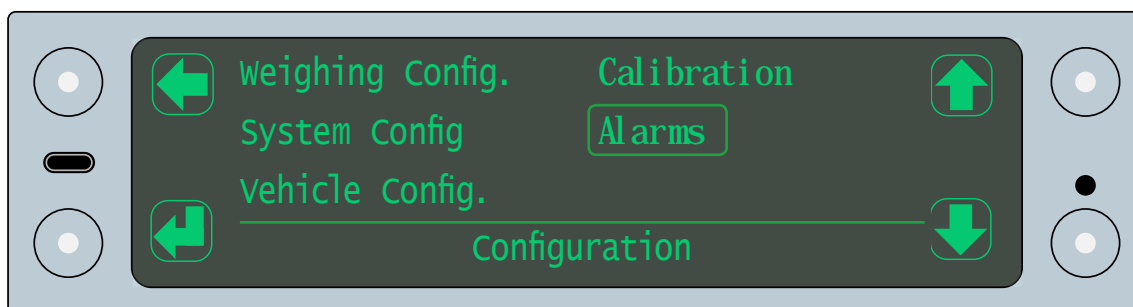

5. Tap the select button to open the alarms menu

## Activate alarms

1. Tap the scroll up or scroll down buttons to highlight the alarms on/off menu

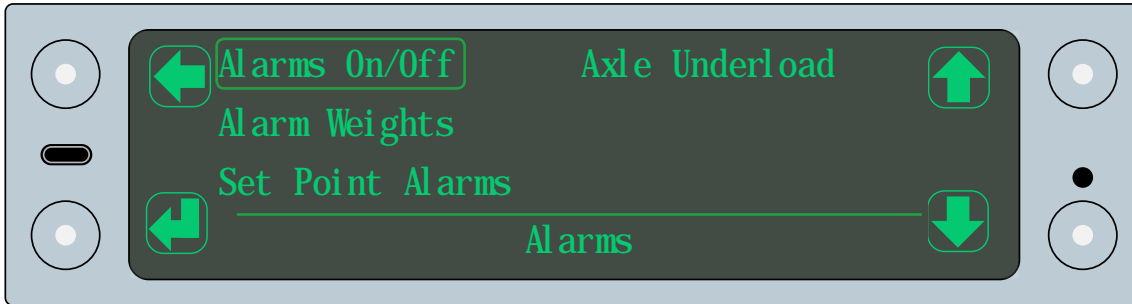

2. Tap the select button to open the alarms on/off menu

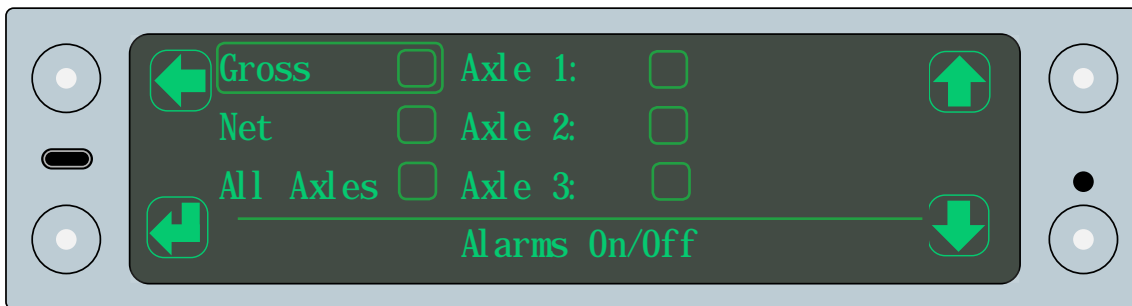

3. Tap the scroll up and down buttons to highlight an alarm
4. Tap the select button to activate the alarm setting
5. Tap the yes button to activate the alarm
6. Tap the back button to return to the alarms on/off menu
7. Repeat steps 3 to 6 to activate the individual axle alarms
8. Tap the back button to return to the alarms menu



## Setting alarm weights

1. Tap the scroll up or scroll down buttons to highlight the alarm weights menu

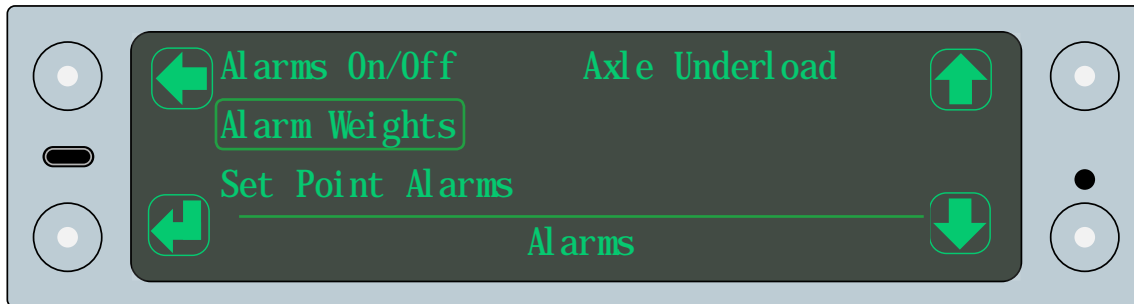

2. Tap the select button to open the alarm weights menu

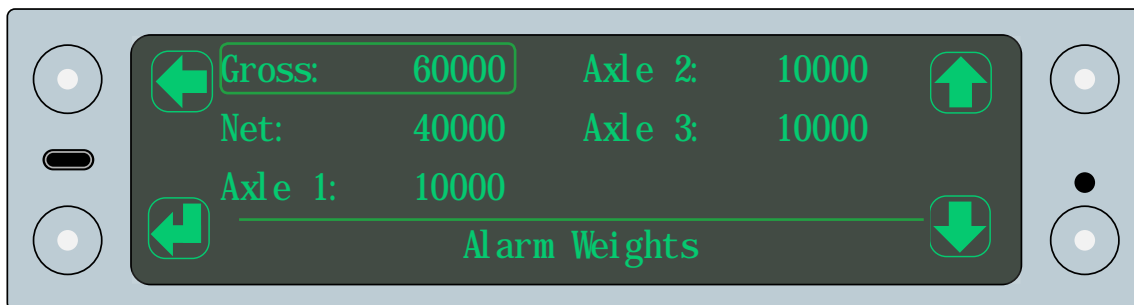

3. Tap the scroll up or scroll down buttons to highlight an alarm weight
4. Tap the select button to select an alarm weight
5. Use the cycle, scroll and select buttons to input the weight limit that will trigger the alarm
6. Tap the back button to return to the alarm weights menu
7. Repeat steps 3 to 6 to set the alarm weights for the net and axle alarms
8. Tap the back button to return to the alarms menu

## Setting set point alarms

1. Tap the scroll up or scroll down buttons to highlight the set point alarms menu

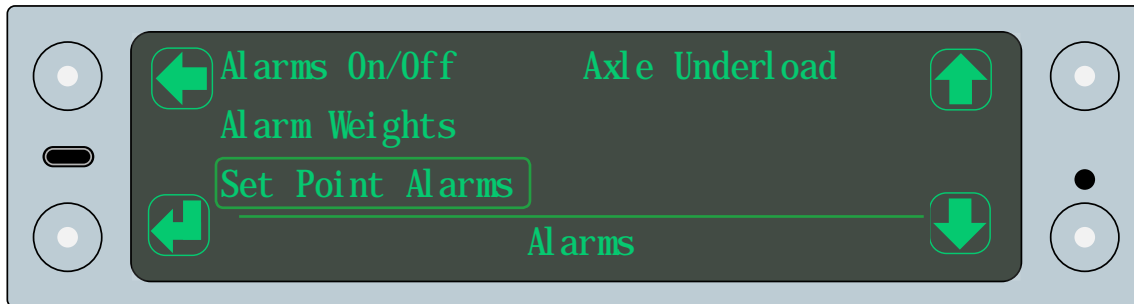

2. Tap the select button to open the set point alarms menu

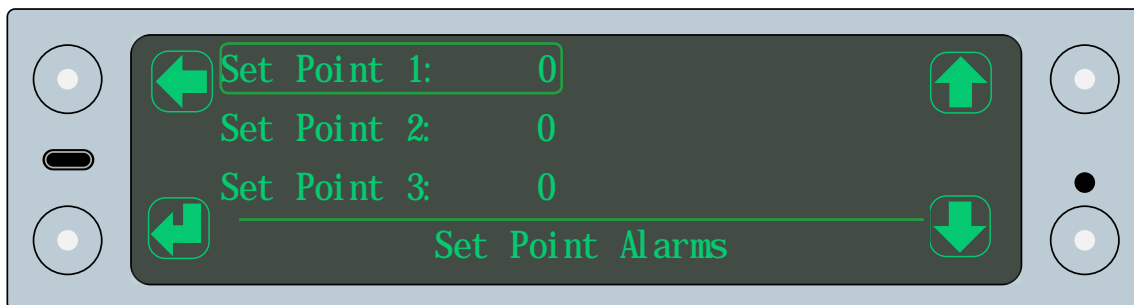

3. Tap the scroll up or scroll down buttons to highlight a set point alarm
4. Tap the select button to select a set point alarm
5. Use the cycle, scroll and select buttons to input the weight that will trigger the set point alarm
6. Tap the back button to return to the set point alarms menu
7. Repeat steps 3 to 6 to set the weights for each set point alarm
8. Tap the back button to return to the alarms menu

## Axle underload alarm

Axle underload can occur when a load over the rear of the vehicle causes the steering axles at the front to raise and lose traction. This is usually set on the first junction box on the vehicle.

The axle underload alarm can be triggered when the weight on the front axles is less than a percentage of the current gross weight of the vehicle.

1. Tap the scroll up or scroll down buttons to highlight the axle underload menu

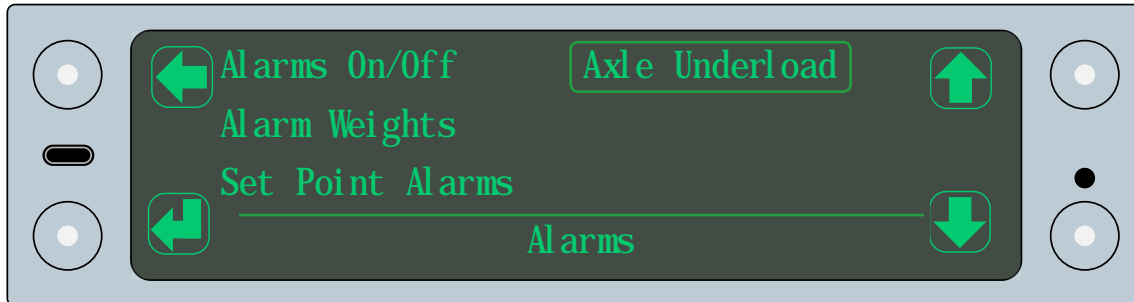

2. Tap the select button to open the axle underload menu

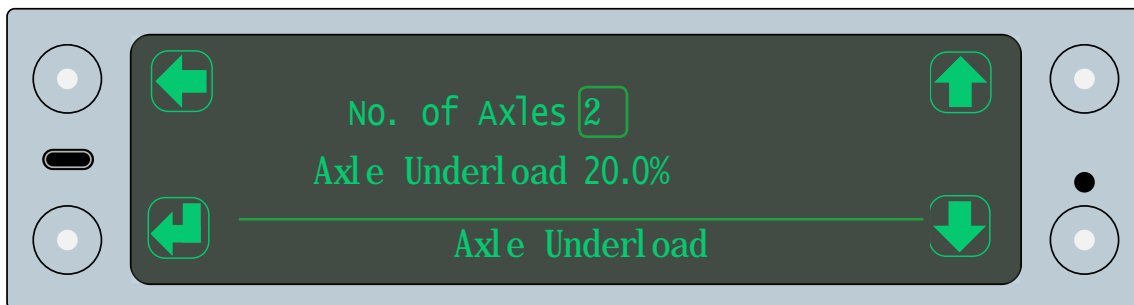

3. Tap the select button to activate the number of axles setting
4. Tap the scroll up or scroll down buttons to set the number of front axles which may be affected by an underload
5. Tap the back button
6. Tap the scroll up or scroll down buttons to highlight the axle underload option
7. Tap the select button to activate the setting
8. Tap the scroll up or scroll down buttons to set the axle underload percentage. This is the percentage decrease of the zero weight value on the axle that will trigger the alarm
9. Tap the back button to return back to the axle underload, alarms or vehicle config menus

# Calibration

## Overview

Once a system has been configured, it must be calibrated using the display unit installed in the cab.

If there are multiple junction boxes, each must be calibrated. For example; A truck and a trailer will contain multiple junction boxes, one for the truck, one for the trailer.

Ensure all junction boxes are connected to the display unit before starting the calibration.

---

Ensure that you know the gross vehicle weight (GVW) before you calibrate the system

---

Two sets of vehicle measurements must be taken:

- Zero weights. This is the weight measurement of each axle when the vehicle has an empty payload
- Span weights. This is the weight measurements for each axle when the vehicle has a payload as close to GVW as possible

The display unit will show a message to indicate the current stage of the configuration and calibration process:

- Config required. This indicates that the vehicle has not yet been configured. See "Configuration" on page 41
- Zero required. This indicates that the vehicle configuration is complete, but the zero process is complete. See "Zero calibration" on page 92
- Span required. This indicates that the vehicle configuration is complete and the zero process is complete, but the span process is not complete. See "Span calibration" on page 94

## Weighing the vehicle

Each axle on the vehicle must be weighed in order to calibrate the system. This can be done using weigh pads or a weigh bridge.

Vehicle weighing should be performed on a flat, level surface, in calm weather conditions. If possible, weigh the vehicle indoors.

### Weigh pads

1. Use one pair of weigh pads per axle.

If possible, weigh all axle at the same time. If not, use levelling mats to maintain the overall level of any axles which are not being weighed.

2. Add together the weight measurements for both sides of the axle to calculate the current weight of the axle.



### Weigh bridge

The weigh bridge must have a level approach.

1. Drive the vehicle on to the weighbridge
2. Take the weight measurement
3. Drive the front axle off the weigh bridge
4. Take the weight measurement



5. Drive the vehicle off the weighbridge, one axle at a time. Take the weight measurements until you have a value for each time an axle is removed from the weigh bridge

It is recommended that you copy or recreate the zero weights and span weights tables to complete and calculate the weight values for each axle. See “Zero and span weights tables” on page 117. See below for an example of this calculation.

It is recommended that the same weighbridge is used to take all weight measurements for both the zero and span calibration processes.

Weighbridge Measurements		Weight Calculation	Axle Weight
G =	11500	Gross Weight = G	11500
a =	9500	Axle 1 = g - a	2000
b =	7500	Axle 2 = a - b	2000
c =	6000	Axle 3 = b - c	1500
d =	4500	Axle 4 = c - d	1500
e =	3000	Axle 5 = d - e	1500
f =	1500	Axle 6 = e - f	1500

The example above shows an how each axle weight can be derived by subtraction using a weighbridge.

## How to calibrate the system

Use the TruckWeigh® display unit installed in the cab to calibrate the system.

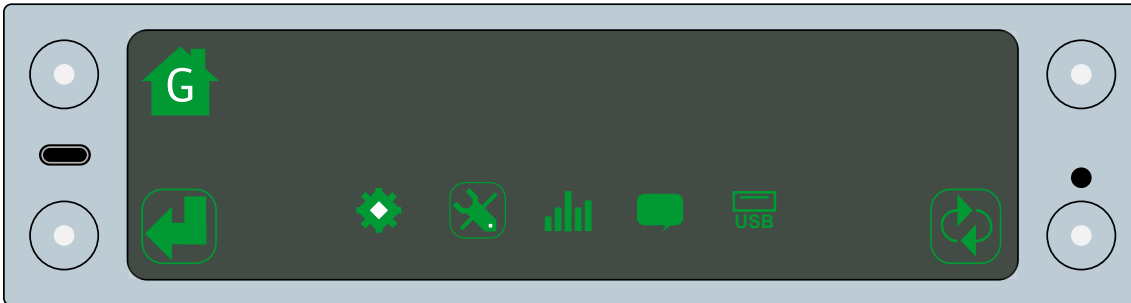

See “Display unit operation” on page 43 for an overview on how to use the TruckWeigh® display unit

1. Tap the toggle mode button to open the gross display mode
2. Tap the cycle button until the configuration option is highlighted
3. Tap the select button to open the configuration menu

---

If multiple junction boxes are connected to the system, you are prompted to select a junction box.  
Select the junction box you want to calibrate.

---

4. Tap the scroll up or scroll down buttons until the calibration option is highlighted

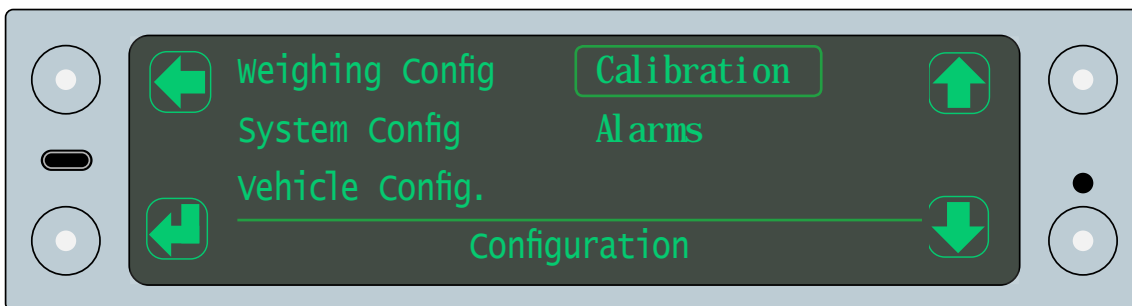

5. Tap the select button to open the calibration menu



## Zero calibration

1. Tap the scroll up or scroll down buttons until the zero option is highlighted

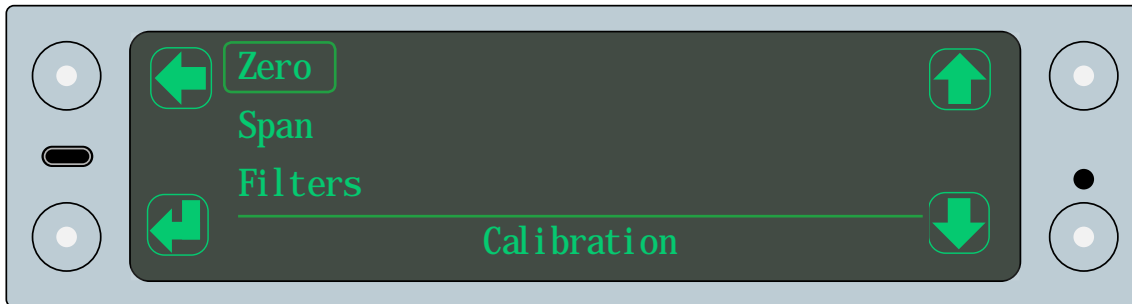

2. Tap the select button to open the zero weights menu
3. Tap the scroll up or scroll down buttons to highlight the junction box which is linked to the sensors on the axle

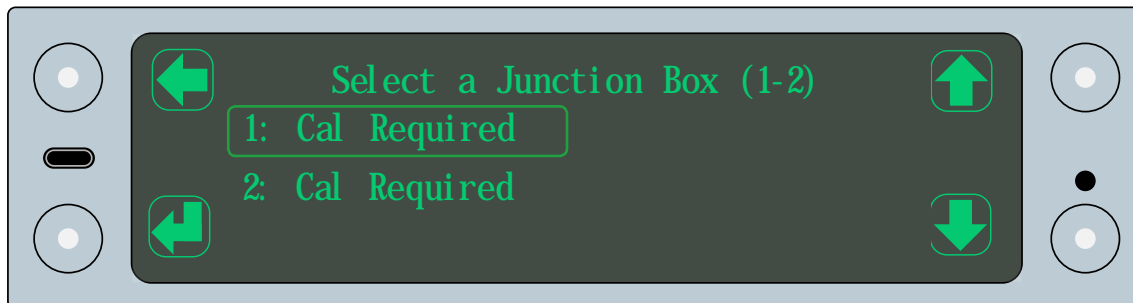

4. Tap the scroll up or scroll down buttons until the axle weights option is highlighted

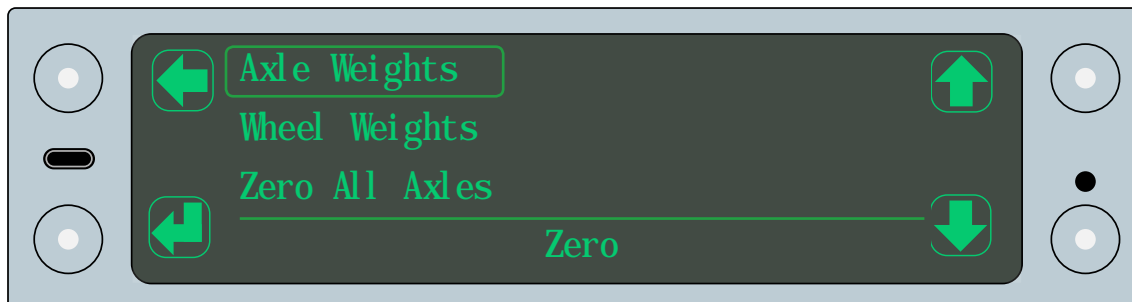

5. Tap the select button to open the axle zero weights for the junction box

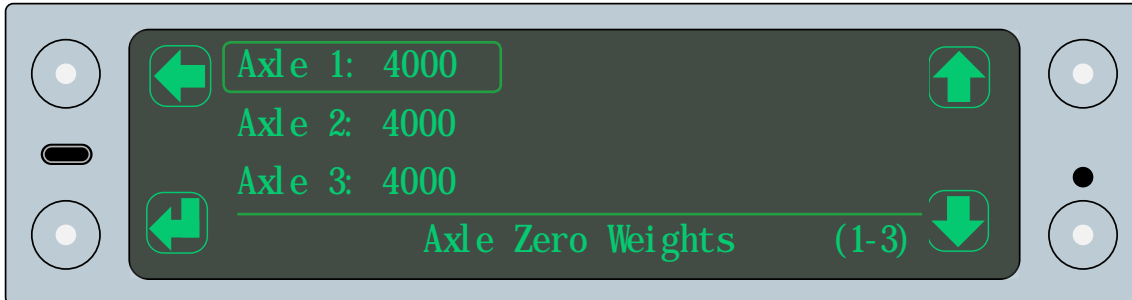

The axle zero weights page shows the current weight values for each axle in the system. The weights need to reflect the measurements taken for each axle with an empty payload. See "Weighing the vehicle" on page 89

6. Tap the scroll up or scroll down arrows to highlight an axle you want to edit
7. Tap the select button to enable the weight entry field
8. Tap the scroll up or scroll down arrows to adjust the first number in the weight measurement
9. Tap enter to keep the number and move to the next number
10. Repeat steps 8 and 9 until the full weight value is displayed
11. Repeat steps 6 to 10 to enter the zero values for each axle. For example:

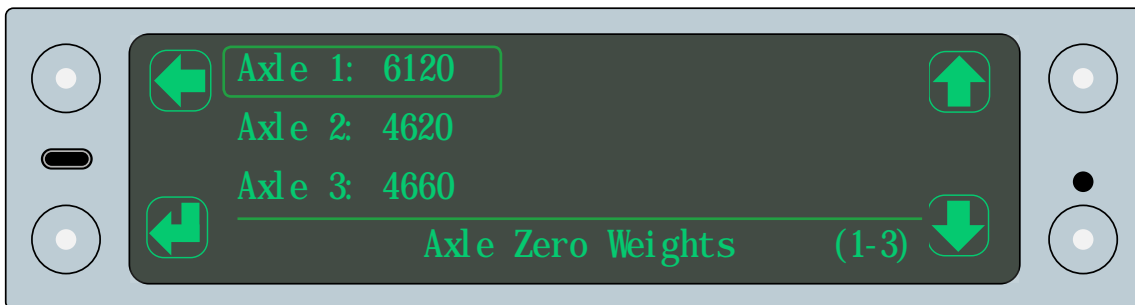

12. Tap the back button to return to the set zero weights menu

13. Tap the scroll up or scroll down buttons to highlight the zero all axles option

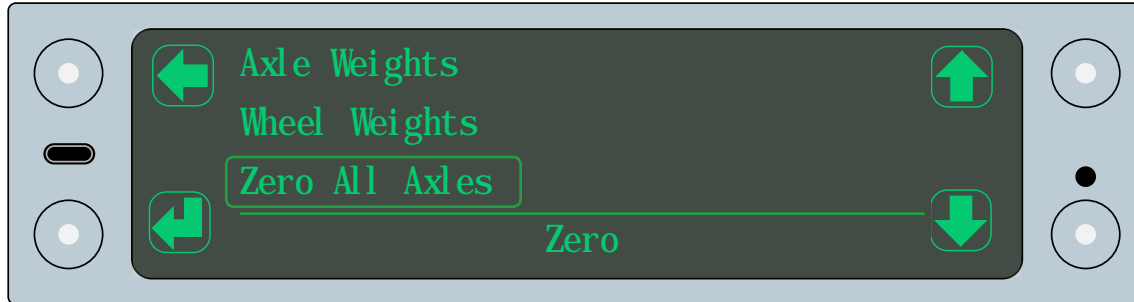

It is recommended that vehicle is positioned back on the weighbridge before selecting the zero all axles option

14. Tap the select button
15. Tap the yes perform the zero calibration
16. Repeat Steps 3 to 15 to set the zero weights for the axles on any additional junction boxes
17. Tap the back button to return to the calibration menu

The wheel weights option provides an alternative method for performing the zero calibration. Use this option to input the weight values for each individual wheel, rather than the axle weights. This can only be done if weighpads are used to measure the wheel weights

## Span calibration

1. Tap the scroll up or scroll down buttons until the span option is highlighted

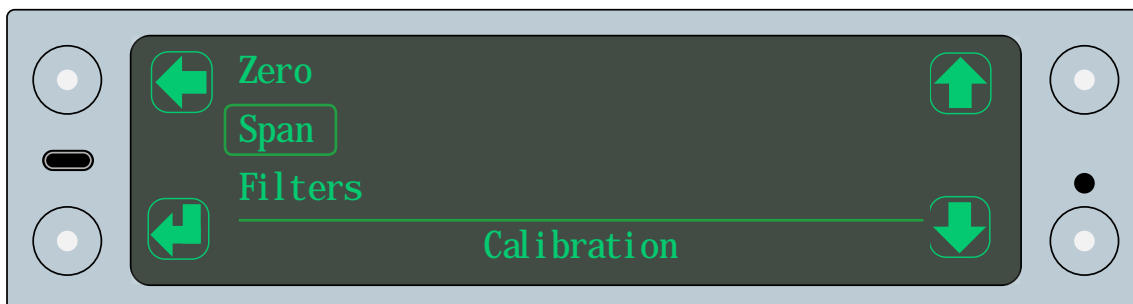

2. Tap the select button to open the span menu

3. Tap the scroll up or scroll down buttons until the axle weights option is highlighted

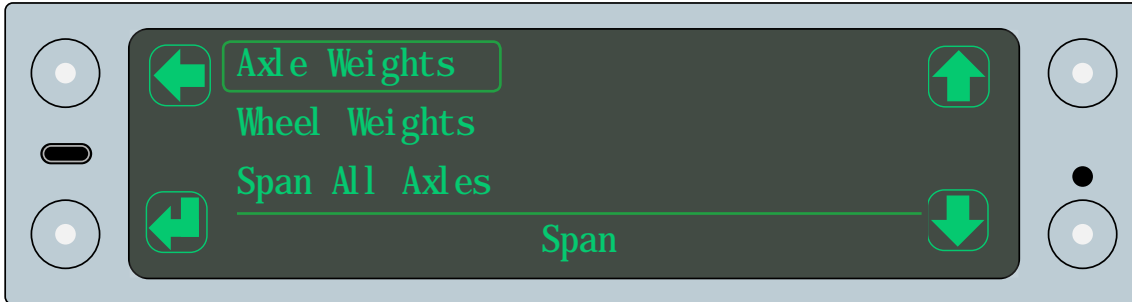

4. Tap the scroll up or scroll down buttons to highlight the junction box which is linked to the sensors on the axle

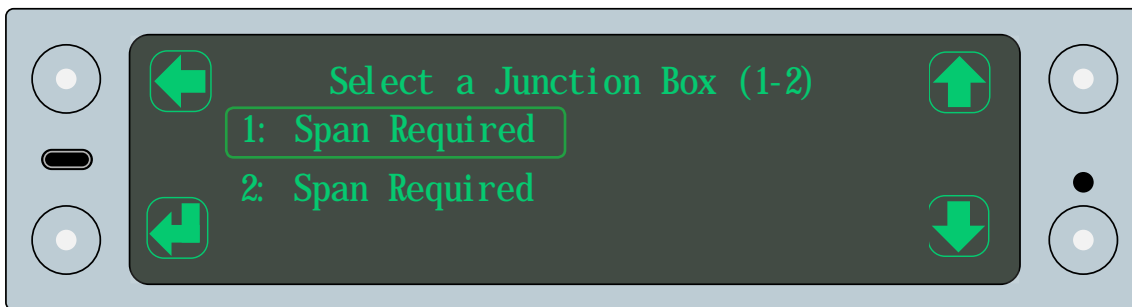

5. Tap the select button to open the axle span weights for the junction box

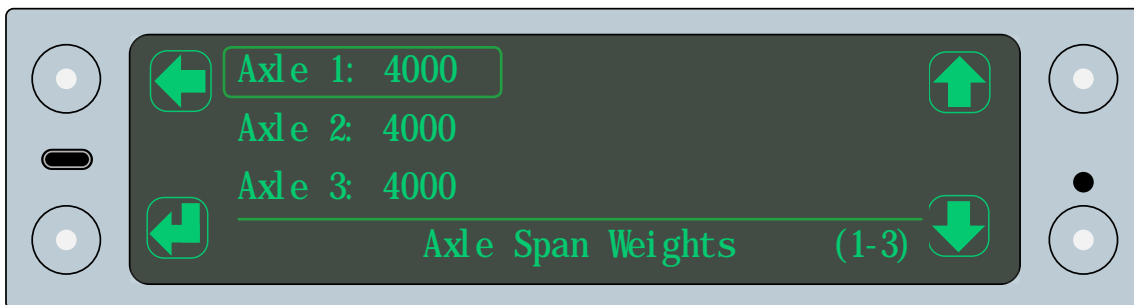

The axle span weights page shows the current weight values for each axle in the system. These values need to reflect the weight measurements taken for each axle with a payload as close to GVW as possible. See "Weighing the vehicle" on page 89

Tap the scroll up or scroll down arrows to highlight an axle you want to edit

6. Tap the select button to enable the weight entry field
7. Tap the scroll up or scroll down arrows to adjust the first number in the weight measurement

8. Tap enter to keep the number and move to the next number
9. Repeat steps 8 and 9 until the full weight value is displayed
10. Repeat steps 6 to 10 to enter the span values for each axle. For example:

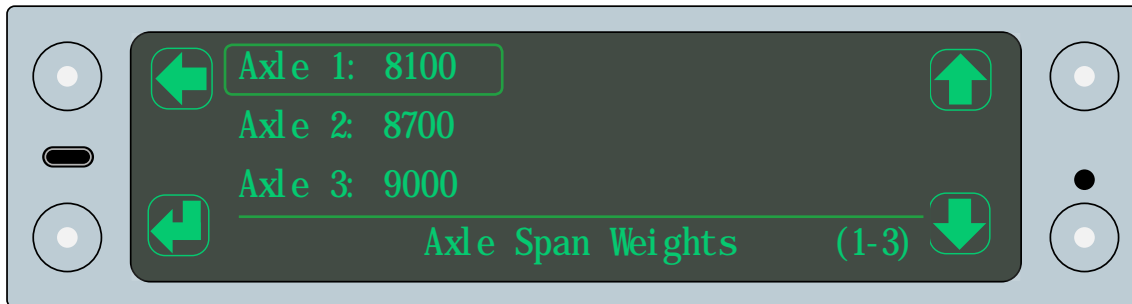

11. Tap the back button to return to the set span weights menu
12. Tap the scroll up or scroll down buttons to highlight the span all axles option





---

It is recommended that vehicle is positioned back on the weighbridge before selecting the span all axles option

---

13. Tap the select button
14. Tap the yes button perform the span calibration
15. Repeat Steps 3 to 15 to set the span weights for the axles on any additional junction boxes
16. Tap the back button to return to the calibration menu

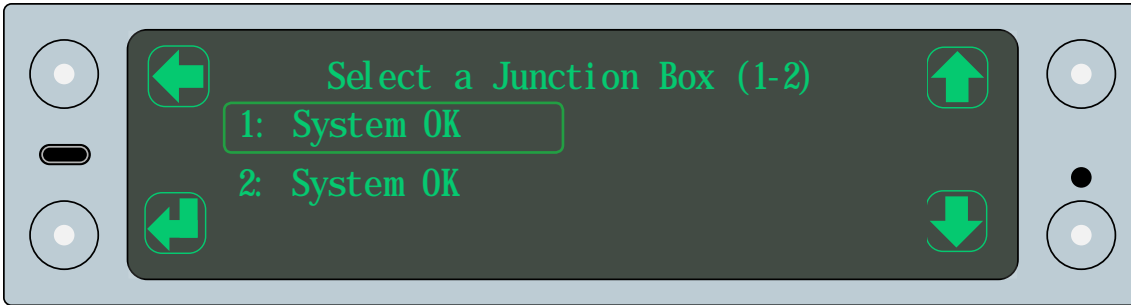
The junction boxes will show as System OK in the select junction box menus when the calibration is complete:





# System options



## Overview

The TruckWeigh® system has a range of additional options that allow you to update and access additional functionality. This includes:

- Display settings
- Language options
- Diagnostics
- System messages
- USB upgrades to system
- Exporting configuration and calibration settings

Use the TruckWeigh® display unit installed in the cab to access the additional system settings.

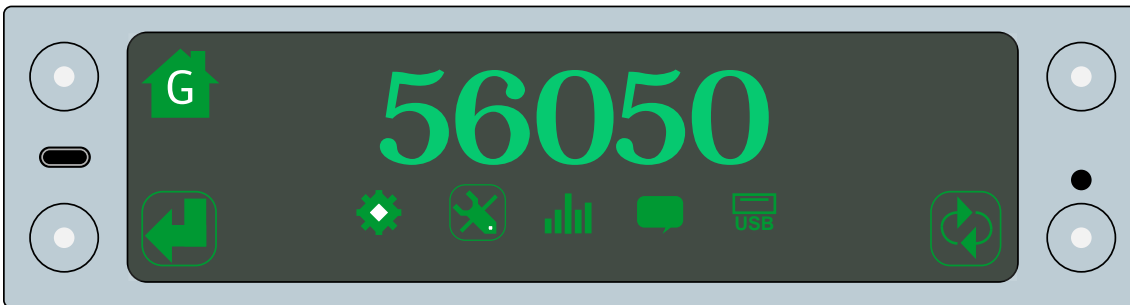

See “Display unit operation” on page 43 for an overview on how to use the TruckWeigh® display unit

## Display settings

The user settings allow you to adjust the screen settings for the display monitor.

You can edit the following display settings:

- Screen saver. The screen saver will activate when the display monitor is not in use. Use this option to set the delay time between the last action taken on the monitor and when screen saver is activated
- Brightness. Use this option to increase or decrease the brightness of the display monitor
- Key Bleep. A bleep can be made when the display monitor is activated. Tick this option to activate the key bleep
- Display Time. Tick this option to display the current time on the home screen of the monitor

1. Tap the toggle mode button to open the gross display mode
2. Tap the cycle button until the user settings option is highlighted
3. Tap the select button to open the user settings menu
4. Tap the scroll up or scroll down buttons until the display option is highlighted

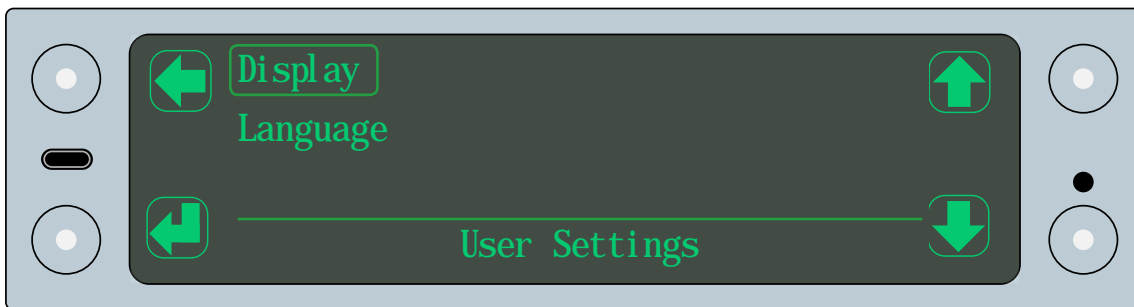

5. Tap the select button to open the display menu:

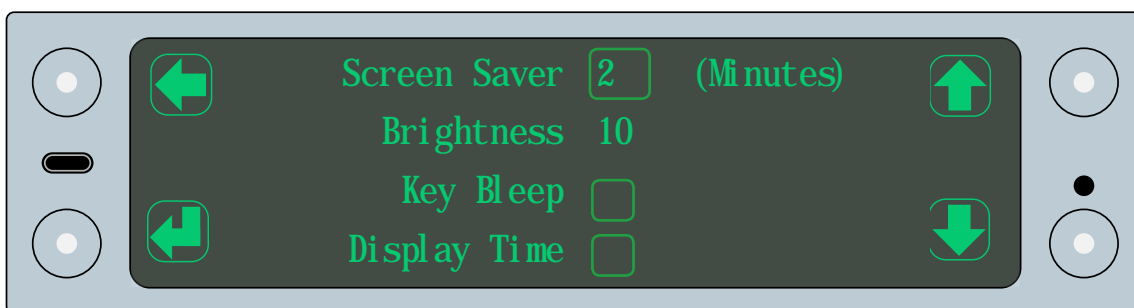

6. Tap the scroll up or scroll down buttons to highlight an option

7. Tap the select button to activate the option
8. Use the scroll, tick and select buttons to adjust the setting
9. Tap the back button to return to the display settings
10. Tap the back button to return to the user settings menu

## Language options

The information in the display monitor can be displayed in a different language. You can edit the following language settings:

- Language
- Date Format

1. Tap the toggle mode button to open the gross display mode
2. Tap the cycle button until the user settings option is highlighted
3. Tap the select button to open the user settings menu
4. Tap the scroll up or scroll down buttons until the language option is highlighted

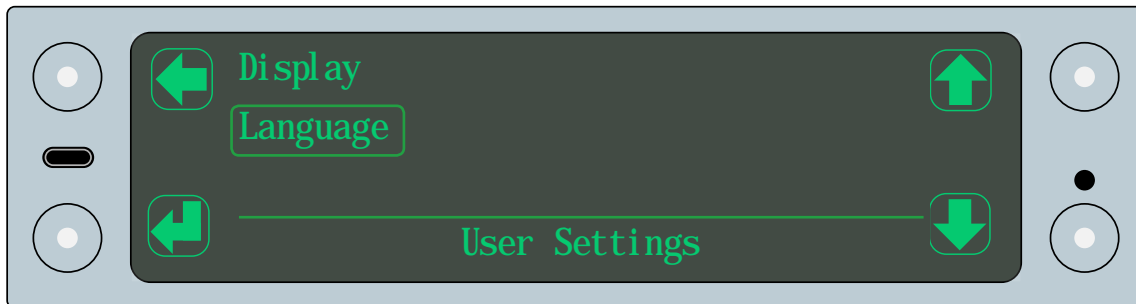

5. Tap the select button to open the language menu:

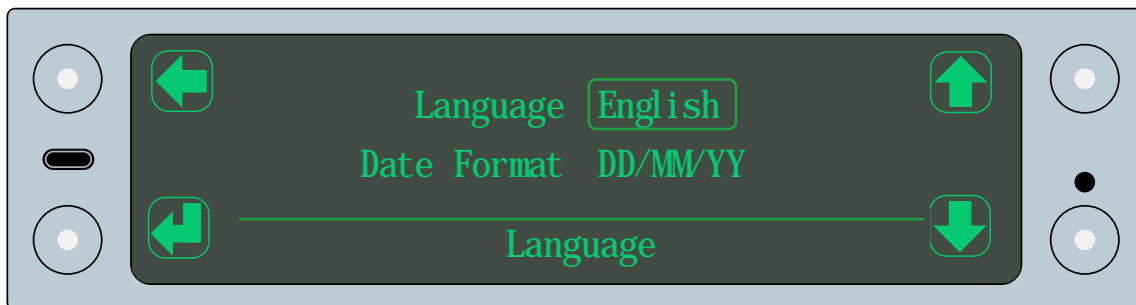

6. Tap the scroll up or scroll down buttons to highlight an option
7. Tap the select button to activate the option
8. Use the scroll, tick and select buttons to adjust the setting

9. Tap the back button to return to the display settings
10. Tap the back button to return to the user settings menu

## Diagnostics

System diagnostics show you a range of current information about your TruckWeigh® system and provides access to the system logs.

1. Tap the toggle mode button to open the gross display mode
2. Tap the cycle button until the diagnostics option is highlighted
3. Tap the select button to open the diagnostics menu

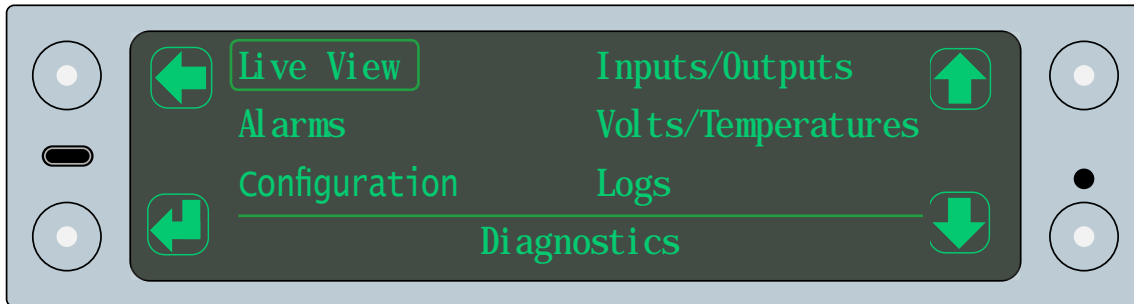

## Live view

The live view shows the current information about each sensor on your vehicle:

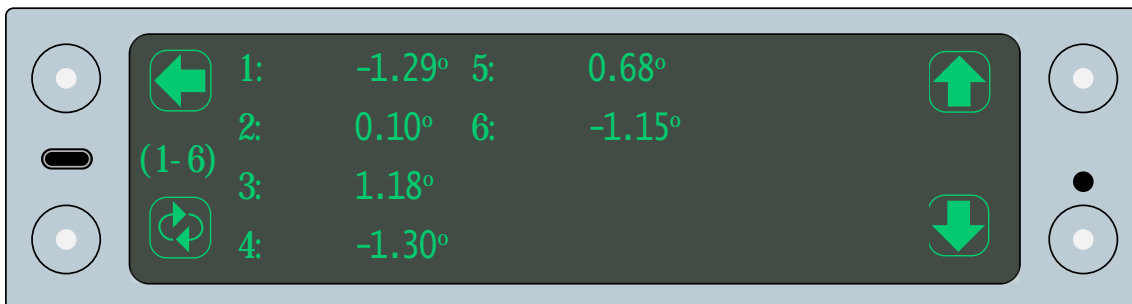

Use the cycle button to cycle between the measurement readings and weight calculations for the sensors.

## Alarms

Alarms allows you to view the current alarm settings.

This includes whether the alarm is active and the weight which will trigger it.

1. Tap the scroll up or scroll down buttons to highlight an option

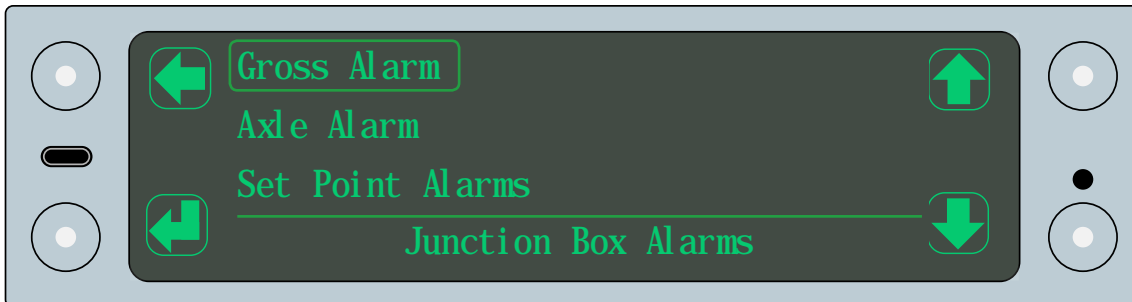

2. Tap the select button to view the settings:

The gross alarm shows the total gross weight value and the gross weight values for each junction box that will trigger the alarm:

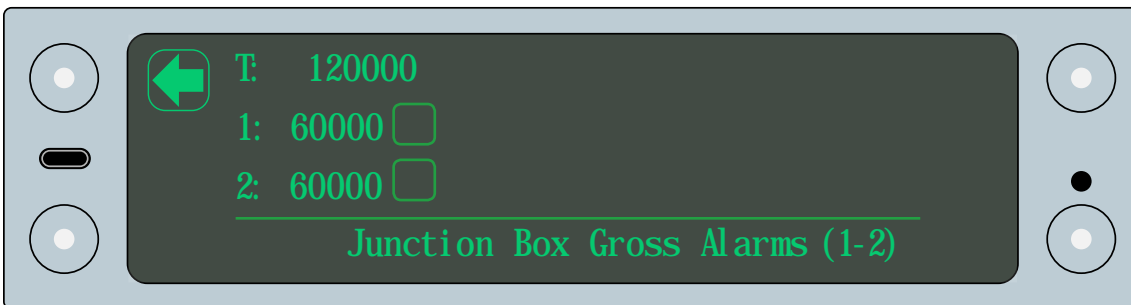

The axle alarms show the weight values that will trigger the alarm for each axle:

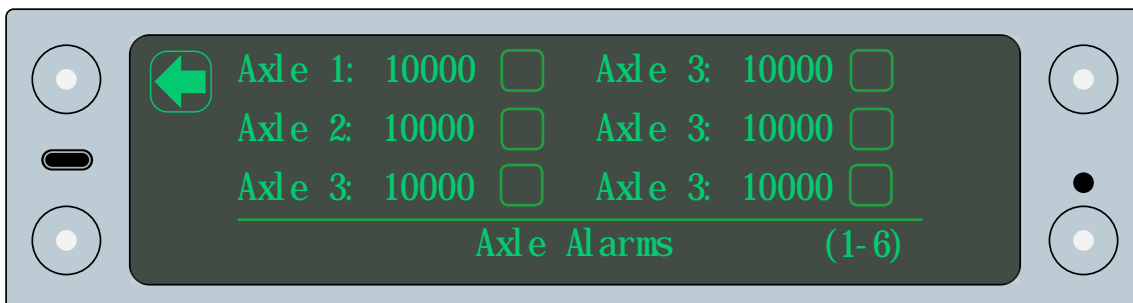

The set point alarms shows the weight values that will trigger the alarms for each set point which has been configured:

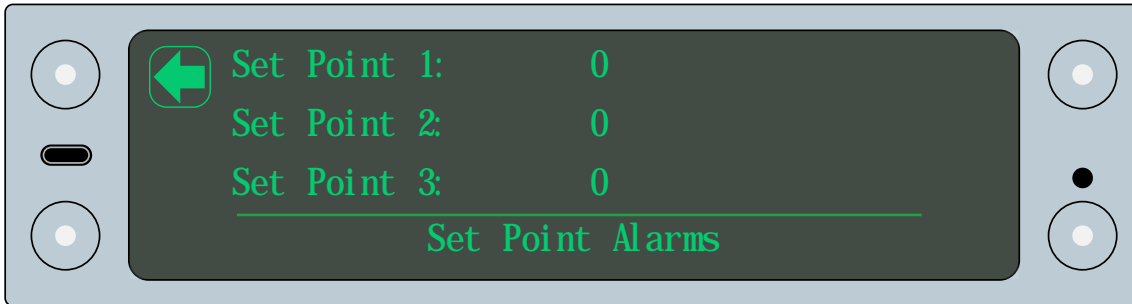

## Configuration

The configuration menu provides access to the configuration details for the system:

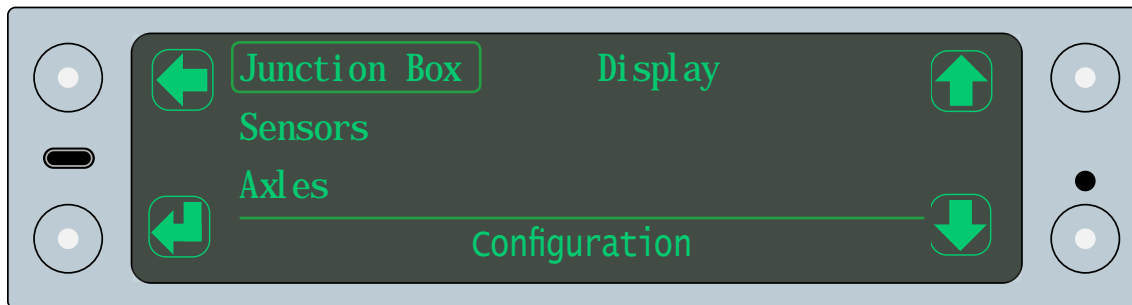



Each submenu shows configuration details about the feature which has been configured. There are 4 submenus:

- Junction box. This shows the current details about each junction box in your system. The junction boxes are configured when they are installed. See “Junction box orientation” on page 75. The diagnostic details include:
  - Firmware version numbers
  - Junction box serial number
  - Sensor and axle numbers
  - Orientation and sensor configuration
  - Zero and span weight calibration values
- Sensors. This shows the current details about each sensor on the system. The sensors are configured when they are installed. See “Sensor configuration” on page 80. The diagnostic details include:
  - Firmware version numbers
  - Sensor serial numbers
  - Sensor type and orientation
  - Filters
  - Gain factors
- Axles. This shows the axle configuration for your system. The axles are configured in the configuration process. See “Axle configuration” on page 76. The diagnostic details include:
  - Axle type
  - Number of sensors
  - Zero and span weight calibration values
- Display. This shows the display settings for your monitor. The display settings can be changed. See “Display settings” on page 101. The diagnostic details include:
  - Firmware version numbers
  - Display unit serial numbers
  - Weighing units
  - Brightness settings
  - Power on screen setting

## Inputs / outputs

The inputs / outputs menu shows the inputs and outputs for the system.

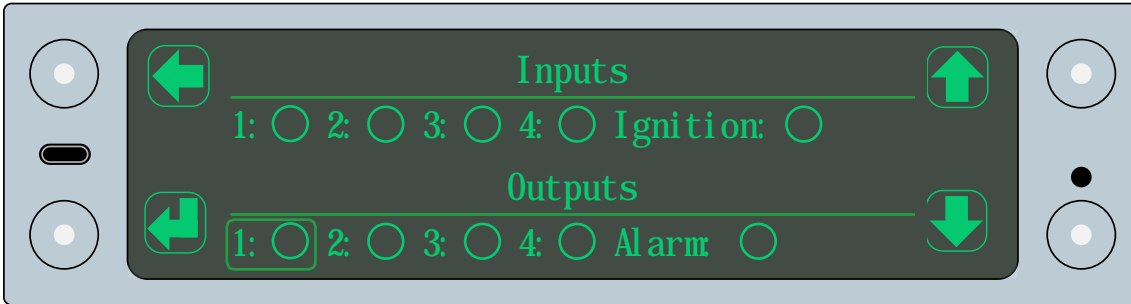

This indicates which options have been activated.

## Volts / temperatures

The volts / temperatures menu provides access to the voltage and temperature measurements for the junction boxes and display unit::

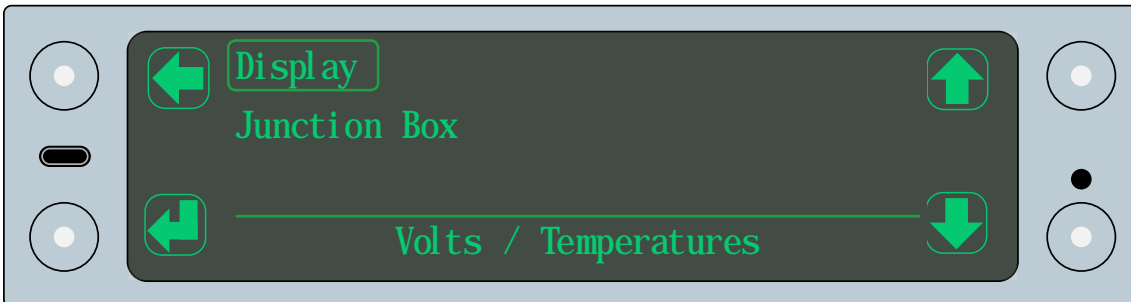

Each sub menu shows the values for the associated hardware.

## Logs

The logs menu allows you to access the system logs:

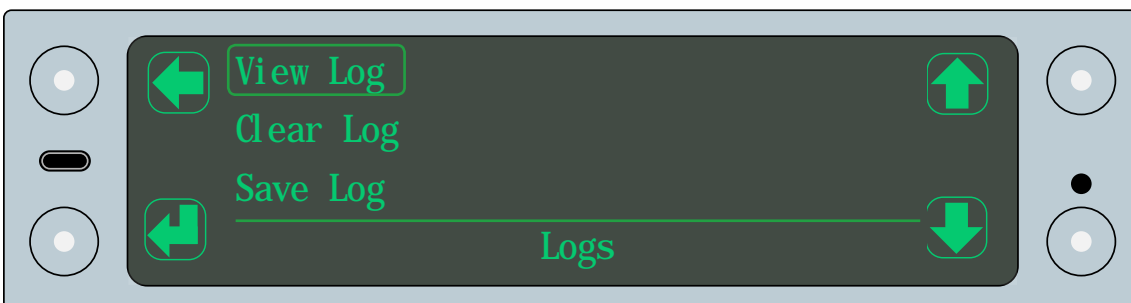

There are three options:

- View log
- Clear log. Use this option to clear all data from the log
- Save log. Use this option to save the log to a USB

## System messages

The system messages menu shows a list of recent messages generated by the system

1. Tap the toggle mode button to open the gross display mode
2. Tap the cycle button until the system messages option is highlighted
3. Tap the select button to open the system messages menu

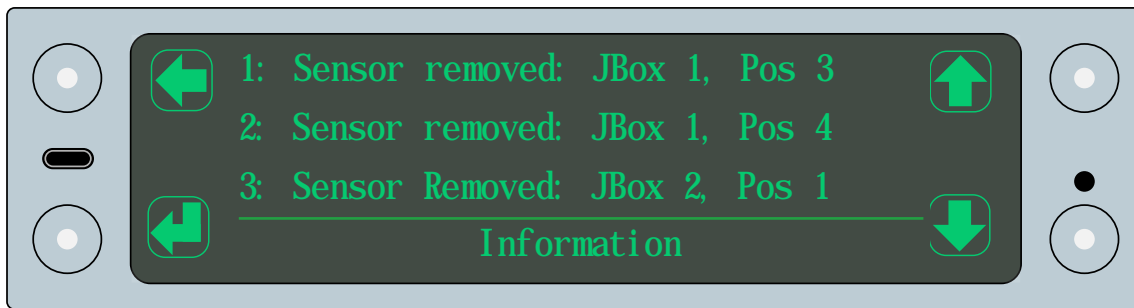

4. Tap the scroll up or scroll down buttons to scroll through the system messages

## USB functions

A USB port is available on the display monitor. The USB menu provides access to the functions which can be performed when a device is plugged in to the USB port.

1. Tap the toggle mode button to open the gross display mode
2. Tap the cycle button until the USB option is highlighted
3. Tap the select button to open the USB menu

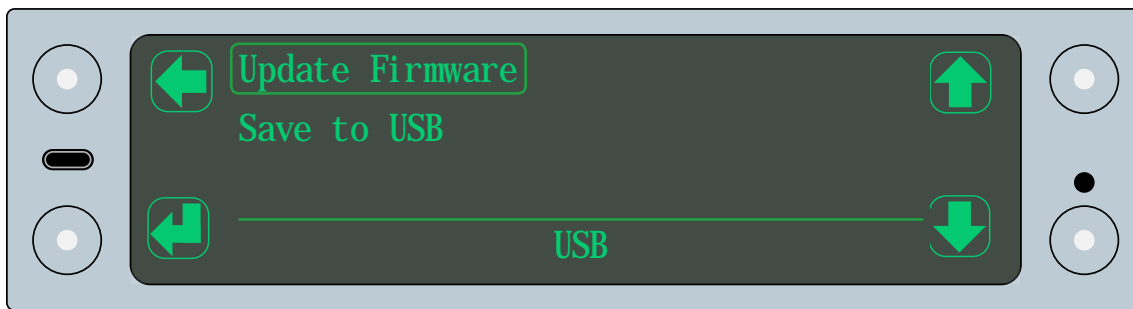

## Update firmware

The update firmware option allows you to update the firmware installed on a junction box.

Open the menu and select a junction box to update. The menu displays the firmware update available on the USB

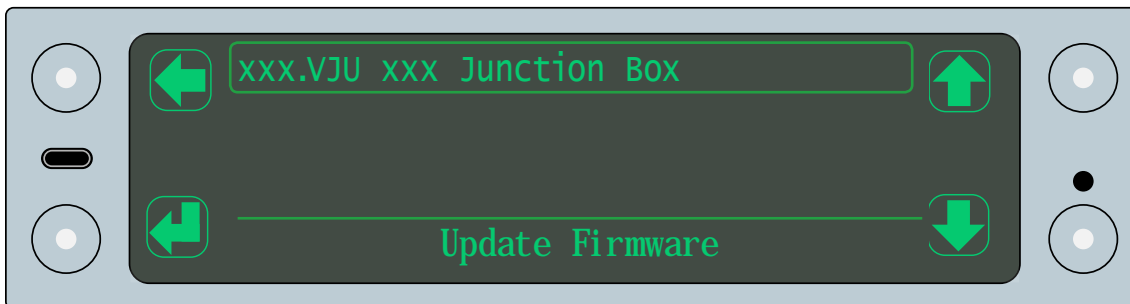

Select the update file and tap the tick button to update the firmware on the junction box.

A progress bar will show the progress of the update and a confirmation message is displayed when it is complete.

---

Do not power down the monitor during the firmware update process.

---

## Save to USB

The save to USB option allows you to save the current configuration and calibration settings on a junction box.

Open the menu and select a junction box. Tap the yes button to save its settings. A confirmation message is displayed when it is complete:

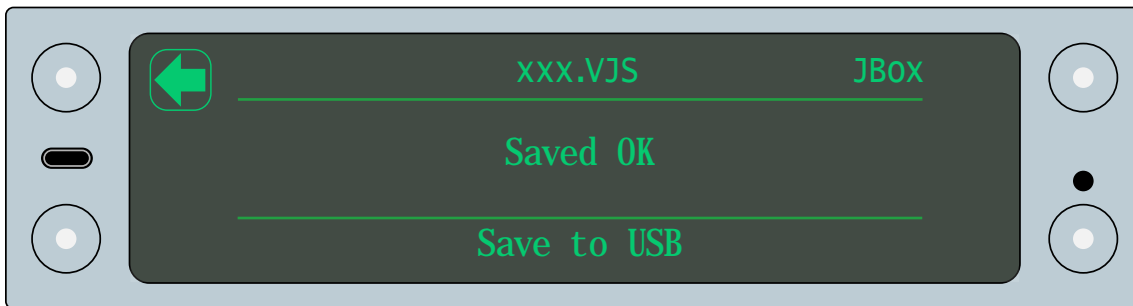



# Appendix A



## System configuration table

Junction box: \_\_\_\_\_

Orientation: \_\_\_\_\_

Axle		Sensors							
		Vehicle Left Side				Vehicle Right Side			
Axle No.	Type	Position No.	Sensor Type	Orientation	Serial No.	Position No.	Sensor Type	Orientation	Serial No.
1		1				2			
2		3				4			
3		5				6			
4		7				8			
5		9				10			
6		11				12			
7		13				14			
8		15				16			
9		17				18			
10		19				20			

It is recommended that you photocopy this table and use it to record the details of the sensors on your vehicle. If you have multiple junction boxes, complete one table per junction box.

If a single sensor used to monitor both sides of an axle, enter its details in the vehicle left side columns and leave the vehicle right side columns blank.

## Zero and span weights tables

Zero weights:

Weighbridge Measurements		Weight Calculation	Axle Weight
G =		Gross Weight = G	
a =		Axle 1 = g - a	
b =		Axle 2 = a - b	
c =		Axle 3 = b - c	
d =		Axle 4 = c - d	
e =		Axle 5 = d - e	
f =		Axle 6 = e - f	
g =		Axle 7 = f - g	
h =		Axle 8 = g - h	
i =		Axle 9 = h - i	
j =		Axle 10 = i - j	

## Span weights:

Weighbridge Measurements		Weight Calculation	Axle Weight
G =		Gross Weight = G	
a =		Axle 1 = g - a	
b =		Axle 2 = a - b	
c =		Axle 3 = b - c	
d =		Axle 4 = c - d	
e =		Axle 5 = d - e	
f =		Axle 6 = e - f	
g =		Axle 7 = f - g	
h =		Axle 8 = g - h	
i =		Axle 9 = h - i	
j =		Axle 10 = i - j	

# Appendix B

## 1160 Back Panel D Type Connector Pinouts

### 9 Way Male D Connector – Standard RS232 Port (DTE)

9 Way Male D Type Connector  
View From Front

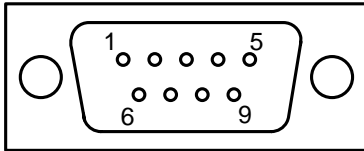

Pin	Function	Description
1		Not Connected
2	RX	RS232 PORT 1 Receive (IN)
3	TX	RS232 PORT 1 Transmit (OUT)
4		Not Connected
5	Gnd	Signal Ground
6		Not Connected
7	RTS	RS232 PORT 1 Handshake (OUT)
8	CTS	RS232 PORT 1 Handshake (IN)
9		Not Connected

## 25 Female D Connector – 1160 General Purpose Expansion Port

25 Way Female D Type Connector  
View From Front

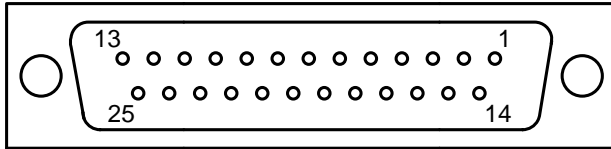

Pin	Function	Description
1	Gnd	Ground
2	TX	RS232 PORT 2 Transmit (OUT)
3	RX	RS232 PORT 2 Receive (IN)
4	RTS	RS232 PORT 2 Handshake (OUT)
5	CTS	RS232 PORT 2 Handshake (IN)
6		Not Connected
7	Gnd	Signal Ground
8		Not Connected
9		Supply Voltage
10	DOUT3	Digital Output 3
11	DOUT1	Digital Output 1
12	DIN3	Digital Input 3
13	DIN1	Digital Input 1
14		Not Connected
15		Not Connected
16	CAN Lo 2	Auxiliary CAN 2 Lo line
17	5V Out	5 Volts DC supply from 1160
18	CAN Lo 1	Auxiliary CAN 1 Lo line
19	CAN Hi 2	Auxiliary CAN 2 Hi line
20		Not Connected
21	CAN Hi 1	Auxiliary CAN 1 Hi line
22	DOUT4	Digital Output 4
23	DOUT 2	Digital Output 2
24	DIN4	Digital Input 4
25	DIN2	Digital Input 2



# Appendix C



## Alarms and Messages

### Warning and Status Messages

Junction box not found	The junction box is not connected to the display unit
Config required	The vehicle has not been configured
Span required	The zero value has been set but the span value has not been set in the calibration process
Zero required	The vehicle has been configured but the zero value has not been set in the calibration process
Error zeroing junction box!	Incorrect junction box and sensor configured
Error spanning junction box!	Spanning error in case of axle zero and span weight almost equal
Axle configuration error	There is a problem with the axle configuration. For example; a standard axle is behind a group front axle
USB device not found	No USB device is connected to save logs or settings
Wrong sensor type for axle!	The sensor type is wrong for the axle. For example; an axle sensor is installed on an air group axle
Invalid weight	An invalid weight was entered

### Message Box Text and Messages







USB POWER FAILURE - REMOVE NOW	The connected USB device is taking too much power. Remove it
Too many sensors found	Too many sensores are attached to the junction box
Duplicate sensor positions found	Two or more sensors have been allocated to the same position

### Log Error Code Text

Gross weight overload	Alarm triggered when the gross weight value exceeds the set alarm value
JBox gross overload	Alarm triggered when the weight on the junction box exceeds the set gross alarm weight value
Axle overload	Alarm triggered when the axle weight value has exceeded the set alarm value
Axle group overload	Alarm triggered when the weight on an axle group exceeds the sum of the alarm values of each axle in the group

Trailer overload	Alarm triggered when the weight on the trailer exceeds the sum of the alarm values of each axle on the trailer
Front axle underload	Alarm triggered when the weight on the front axle is less than a percentage of the current gross weight of the vehicle
Calibration weights invalid	The weights entered for the calibration are invalid. Check the input values
Calibration delta low	The change in sensor reading between zero and span is too small to ensure a good calibration
Calibration opposite motion	The left and right sensors on the axle moved in opposite directions during the span operation
Zero error	An error occurred during the zero operation
Span error	An error occurred during the span operation
Calibration error	An error occurred during calibration
Calibration zero gain error	The gain was calculated as zero, causing an error
Sensor error	A sensor reported an error
Sensor not configured	Sensor configuration is incomplete

## Alarm Icons

	Alarm. Gross weight value has exceeded the set alarm value
	Axle alarm. Axle weight value has exceeded the set axle alarm value
	Axle group alarm. Weight on the axle group has exceeded the sum of the alarm values of each axle in the group
	Axle underload. Weight on the axle is lower than the setup axle weight
	Error. See message log
	Scales. Weight on the display is unstable
	Trailer Alarm. Weight on the trailer has exceeded the sum of the alarm values of each axle on the trailer



# Appendix D

## TRUCKWEIGH II

### Axle Overload Protection for Larger Capacity Vehicles Greater than 7720 lbs (US), 3.5 tonne (RoW)

#### SPECIFICATION

PARAMETERS	MINIMUM	TYPICAL	MAXIMUM	UNIT
<b>SYSTEM</b>				
Accuracy	Better than 2.5%			90 - 110% of full scale
Capacity (GVW)	3.5 and above			Tonne
	7720			lbs
Operating voltage	9		36	VDC (US and RoC)
Operating temperature	-40		70	°C
	-40		158	°F
Current at 24V off sensors			320	mA
Current standby at 24V			10	mA
Weighing modes	Net, Gross, Axles			
<b>INDICATOR</b>				
Type	OLED			
Size	137.65 x 35.89			mm
	5.42 x 1.41			inches
Operating temperature	-30 to +70			°C
	-22 to + 158			°F
Environmental protection	IP51			
Resolution	256 x 64			Dots
Dot pitch	0.53			mm
	0.0208			inches
Signal input port	5 pin connector (for junction box)			
Expansion port	25 D type female connector			
On screen display of weight				
Overload alarm-audible	Optional external alarm sounder on vehical			
Alarm output level (at 24 VDC)	≥85			dB(A)
Password protection	4 digits, manager and user PIN			
Load deliver capability				

Form factor	Din cut out			
<b>TRANSDUCERS</b>				
Transducer types	Up to 32 axle or air transducers			
<b>INTERFACES</b>				
RS232				
No of ports	2			
Type	DTE			
Baud rate	4800, 9600, 19200, 38400, 57600, 115200			
CAN				
No of ports	2			
Baud rate	125, 250, 500			Kbs
DIGITAL I/O				
Inputs				
No of inputs	4			
Voltage	6		36	V
Current	0.5		5	mA
Outputs				
No of outputs	4			
Voltage	12/24			VDC
Current	1			A
<b>ACCESSORIES AND OPTIONS</b>				
Barrier control	12/24VDC output to vehicle body			
Printer capability	Impact or heavy duty type			
Adjustable bracket				

# VPG ONBOARD WEIGHING



## Contact

VPG System UK Ltd

Airedale House,

Canal Road

Bradford BD2 1AG

PH: +44 (0) 1274 771177

FAX: +44 (0) 1274 781178

E-MAIL: [obw.uk@vpgsensors.com](mailto:obw.uk@vpgsensors.com)

[www.vpgonboard.com](http://www.vpgonboard.com)

[vpgonboard.com](http://vpgonboard.com)

DISCLAIMER: ALL PRODUCTS, PRODUCT SPECIFICATIONS AND DATA ARE SUBJECT TO CHANGE WITHOUT NOTICE. Vishay Precision Group, Inc., its affiliates, agents, and employees, and all persons acting on its or their behalf (collectively, "VPG"), disclaim any and all liability for any errors, inaccuracies or incompleteness contained herein or in any other disclosure relating to any product. The product specifications do not expand or otherwise modify VPG's terms and conditions of purchase, including but not limited to, the warranty expressed therein. VPG makes no warranty, representation or guarantee other than as set forth in the terms and conditions of purchase. To the maximum extent permitted by applicable law, VPG disclaims (i) any and all liability arising out of the application or use of any product, (ii) any and all liability, including without limitation special, consequential or incidental damages, and (iii) any and all implied warranties, including warranties of fitness for particular purpose, non-infringement and merchantability. Information provided in datasheets and/or specifications may vary from actual results in different applications and performance may vary over time. Statements regarding the suitability of products for certain types of applications are based on VPG's knowledge of typical requirements that are often placed on VPG products. It is the customer's responsibility to validate that a particular product with the properties described in the product specification is suitable for use in a particular application. You should ensure you have the current version of the relevant information by contacting VPG prior to performing installation or use of the product, such as on our website at [vpgsensors.com](http://vpgsensors.com). No license, express, implied, or otherwise, to any intellectual property rights is granted by this document, or by any conduct of VPG. The products shown herein are not designed for use in life-saving or life-sustaining applications unless otherwise expressly indicated. Customers using or selling VPG products not expressly indicated for use in such applications do so entirely at their own risk and agree to fully indemnify VPG for any damages arising or resulting from such use or sale. Please contact authorized VPG personnel to obtain written terms and conditions regarding products designed for such applications. Product names and markings noted herein may be trademarks of their respective owners.